



CONNECT AND PROTECT

Grounding, Bonding and nVent ERICO Cadweld

Solutions Guide

nvent

ERICO

SUPERIOR SOLUTIONS

Over 100 years of industry experience

Global support network

Comprehensive design and engineering services

Complete range of electrical protection solutions



nVent ERICO

CUSTOMIZED SOLUTIONS FOR THE MODERN WORLD

Since 1903, nVent ERICO has been a leading designer, manufacturer and marketer of precision-engineered solutions serving global niche product markets in a diverse range of telecom, commercial construction, utility and rail applications.

As a trusted industry leader, our products and services are recognized for providing labor and cost-saving solutions for customers throughout the world, while also providing the unparalleled service our customers have come to expect.

Visit nVent.com/ERICO for up-to-date product information available in many languages and the ability to filter product searches with one click.



ERICO

Directory

SOLUTION RESOURCES

Facility Electrical Protection for the 21st Century 5
 Earthing Principles 7

GROUND ROD AND ACCESSORIES

Ground Rods | Copper-Bonded Ground Rods 16
 Ground Rods | Solid Copper Ground Rods 22
 Ground Rods | Chemical Ground Electrodes 23
 Ground Rod Connectors | Ground Rod to Conductor 25

CONNECTORS AND POSITIONERS

Grounding Busbar Connectors 32
 Structural Connectors | Bonding Plates 32
 Structural Connectors | Beam/Flange Bonding Clamps 33
 Structural Connectors 34
 Conductor to Conductor Connectors | Round to Round Connectors 35
 Pipe, Fence and Gate Connectors | Pipe Connectors 40
 Rebar Connectors 44
 Pedestal Connectors 46
 Lugs | Mechanical Lugs 47

CONDUCTORS

Cu-Bond Composite Cable 50
 Insulated Round Conductors 56
 Non-Insulated Round Conductors 56
 Tape 57

GROUNDING AND BONDING

nVent ERICO GEM Ground Enhancement Material 60
 nVent ERICO Quickfill No-Mix Ground Enhancing Backfill – QF25 62
 Inspection Housings 63

Ground Mats and Mesh	66
Ground Plates	67
Ground Points for Concrete	68
Aircraft and Static Grounding	70
GROUNDING BUSBARS	
Grounding Busbars and Supports	74
Intersystem Bonding Termination Bar	82
GROUNDING TOOLS	
Ground Rod Driving Tools	84
Ground Resistance Testers	86
NVENT ERICO CADWELD MOLDS	
Grounding Connection Specifications	92
Cable to Cable Molds	99
Cable to Ground Rod Splice Molds	105
Cable to Ground Rod or Other Rounds	106
Cable to Steel Molds	108
Cable to Lug or Busbar Molds	112
Busbar to Busbar Molds	115
NVENT ERICO CADWELD WELDING MATERIAL, TOOLS AND ACCESSORIES	
Welding Material	122
nVent ERICO Cadweld One Shot	124
nVent ERICO Cadweld Multi	128
Lugs	132
Tools and Accessories	134
TECHNICAL CHARTS	149
INDEX	153

Facility Electrical Protection for the 21st Century

Lightning strikes and the dangerous over-voltage surges caused by lightning and man-made events represent a direct threat to people, buildings and sensitive electronic equipment.

Today, the consequences of an unexpected lightning strike or power surge can be catastrophic for a company. Proper protection can save thousands of dollars in damage, operational downtime and lost business opportunities.

TOTAL FACILITY PROTECTION

The consequences of an unexpected lightning strike or power surge can be catastrophic for a facility:

- Personnel are at risk.
- Critical equipment may be damaged or destroyed.
- Data can be corrupted.
- The costs of operational downtime and lost revenue can be very substantial.

As industries become more dependent on increasingly sensitive equipment, proper protection from lightning and dangerous over-voltage transients is necessary.

With over 60 years of research, testing and product development, nVent ERICO has acknowledged that no single technology can totally eliminate vulnerability to lightning and surges.

The nVent ERICO Six Point Plan of Protection is designed to provide total facility protection by integrating several concepts.

The Six Point Plan will minimize the risk of damage to facilities through:

- Direct Strike Protection
- Grounding and Bonding
- Surge and Over-voltage Transient Protection

THE SIX POINT PLAN OF PROTECTION

- 1 Capture the lightning strike.**
Capture the lightning strike to a known and preferred attachment point using a purpose-designed air terminal system.
- 2 Convey this energy to ground.**
Conduct the energy to the ground via a purpose-designed downconductor.
- 3 Dissipate energy into the grounding system.**
Dissipate energy into a low impedance grounding system.
- 4 Bond all ground points together.**
Bond all ground points to eliminate ground loops and create an equipotential plane.
- 5 Protect incoming AC power feeders.**
Protect equipment from surges and transients on incoming power lines to prevent equipment damage and costly operational downtime.
- 6 Protect low voltage data/telecommunications circuits.**
Protect equipment from surges and transients on incoming telecommunications and signal lines to prevent equipment damage and costly operational downtime.

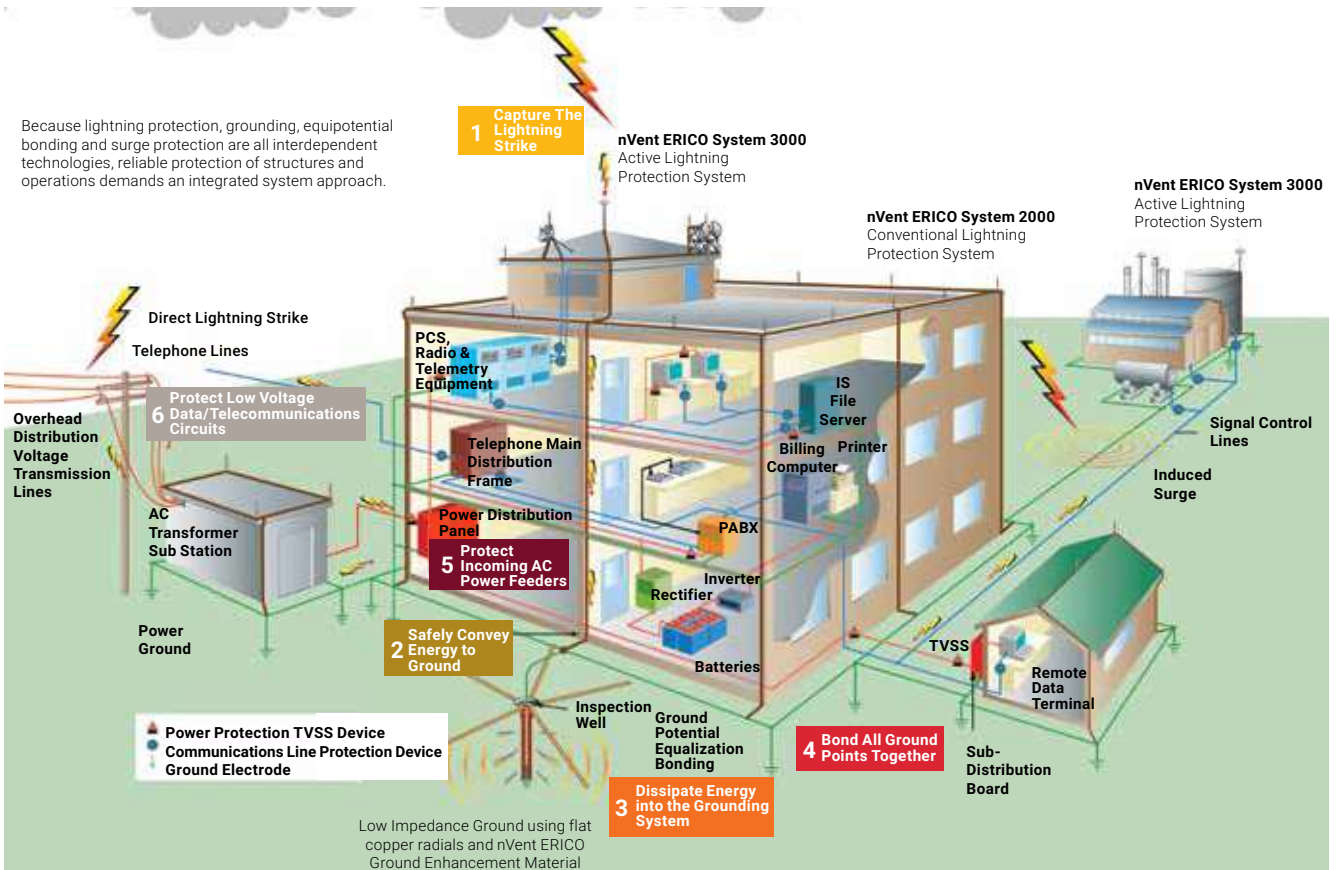

Facility Electrical Protection for the 21st Century

DIRECT STRIKE PROTECTION

nVent ERICO's innovative technology provides two systems for capturing lightning energy: nVent ERICO System 2000 and nVent ERICO System 3000. System 2000 provides conventional air terminal technology to meet traditional needs.

An alternative approach to lightning protection is the System 3000, which utilizes the collection volume method to determine the effective placement of lightning protection to ensure the safe conveyance and dissipation of the lightning energy into the ground. Over 7000 facilities worldwide, including some of the tallest and most vulnerable buildings, are protected by System 3000.

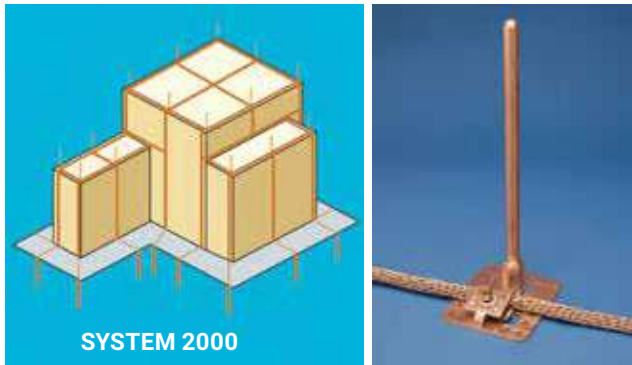

- Well known technology of passive rods or air terminals, familiar to installers
- Air terminals available in aluminum, copper and stainless
- IEC®, B.S., and U.S. Standard Compliant
- Precision manufacturing helps ensure easy assembly and installation
- Computer-aided design to IEC62305, NFPA®-780, AS/NZS1768

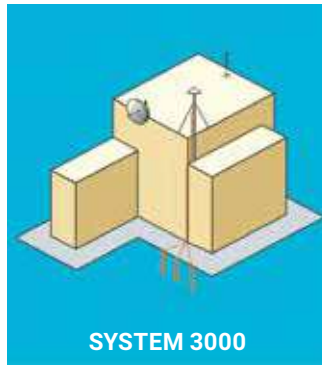

- Advanced lightning protection system based on latest lightning research and technology
- Enhanced area of protection, fewer air terminals needed
- Economical and easy to install
- Fewer downconductors are required
- Designed to protect all types of structures and "open areas"
- Computer-aided design using Collection Volume method

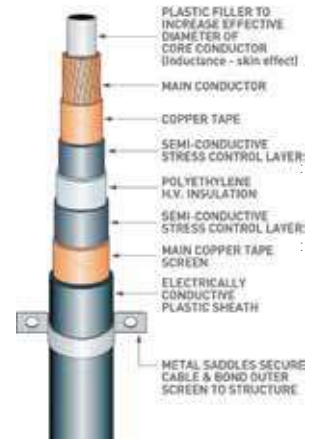

EARTHING AND BONDING

For the efficient performance of a lightning protection system, it is essential that a low impedance ground be provided to facilitate the dissipation of the lightning energy into the earth mass.

Because soil conditions and seasonal patterns vary from site to site, the methods of grounding need to be considered on an individual basis.

As a grounding specialist, nVent ERICO provides a range of grounding systems to suit any application.



nVent ERICO Cadweld Plus

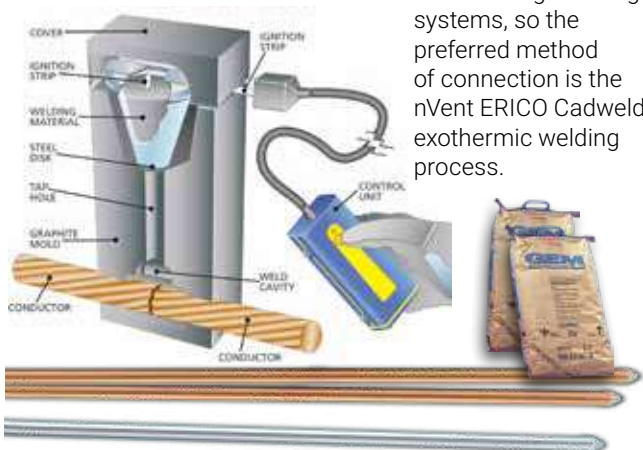

Connections are often the most critical element of grounding systems, so the preferred method of connection is the nVent ERICO Cadweld exothermic welding process.

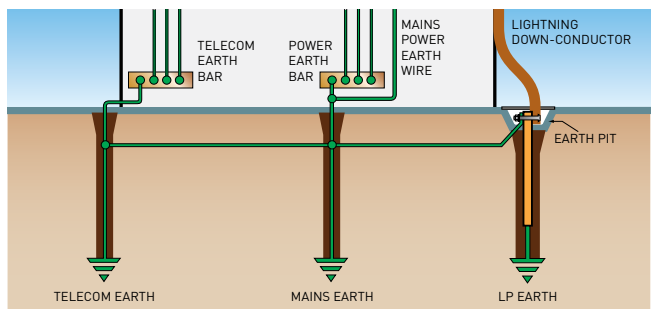

nVent ERICO offers a variety of products, such as ground bars, signal reference grids, ground plates and potential equalization clamps, which are designed to create an equipotential plane and help protect personnel and valuable equipment. nVent ERICO copper-bonded or stainless steel earth rods and nVent ERICO GEM facilitate the transfer of surges and fault currents into the earth, and provide a very long service life due to superior construction and quality.

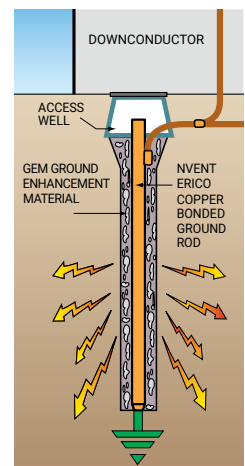

Earthing Principles



INTRODUCTION

Grounding and bonding are an integral part of any modern electrical protection system design. An effective, low-impedance ground system is a key element of this system.

It is crucial to help provide personnel safety, as well as reliable protection for vital equipment and to minimize interruptions of service and costly downtime.

With over a century of experience in the design and manufacture of bonding and grounding products, nVent ERICO, a single source provider, offers what we believe is the best range of long lasting and cost-effective grounding products available.

BASIC DEFINITIONS

Earth: A conducting connection, whether intentional or accidental, between an electrical circuit or equipment and the earth, or to some conducting body that serves in place of the earth.

Bonding: The permanent joining of metallic parts to form an electrically conductive path that will ensure electrical continuity and the capacity to conduct any current likely to be imposed.

THE NEED FOR EARTHING!

There are important reasons why a grounding system should be installed.

1. The most important reason is to help protect people!
2. For protection and safety in the event of unintentional contact with live conductors.
3. To help support maximum safety from electrical system faults and lightning.

It is a fundamental fact that current always flows to the point of lowest potential. The goal of any properly designed earthing system is to ensure that current generated by electrical faults or lightning events flows to this point. A good grounding system results in minimum voltage drop providing maximum safety to people while maintaining the reliability of equipment.

EARTHING CODES AND STANDARDS

Earthing systems vary according to application. For example, the earthing requirements for power systems vary from lightning protection systems or telecommunication systems.

Proper installation of appropriate earthing systems requires knowledge of the needs and layout of the facility. Soil characteristics, grounding conductor materials grounding connections and terminations, are significant factors determining the design of a grounding system. Applicable standards and codes must be followed.

While many codes and standards contain minimum grounding and bonding requirements, the design and installation of electrical grounding systems is one of the most important aspects of any electrical distribution system. However, grounding systems can be misunderstood and therefore improperly designed and installed.

Earthing Principles

WHY IS EARTHING IMPORTANT?

The transient nature of lightning with its associated fast rise times and large magnitude currents mean that special consideration needs to be given to earthing, for lightning protection to be effective. Many factors such as soil resistivity variations, installation accessibility, layout and existing physical features are all site specific and tend to affect decisions on earthing methods. The primary goal of an earthing system for direct strike lightning protection is to:

- Efficiently dissipate lightning energy into the ground
- Help protect equipment and personnel
- Provide equipotential control

EARTHING PRINCIPLES

Low impedance is the key to lightning protection. All grounding conductors should be as short and direct as possible to minimize inductance and reduce peak voltages induced in the system. The earth electrode system must efficiently dissipate lightning surges into the ground by minimizing the impedance of the electrode to earth.

SOIL RESISTIVITY

Soil resistivity is an important design consideration. The resistivity varies markedly for different soil types, moisture content and temperatures and gives rise to variations in ground impedances.

SHORT, DIRECT EARTH CONNECTIONS

The voltage generated by a lightning discharge depends primarily on the risetime of the current and the impedance (primarily inductance) of the path to ground. Extremely fast rise times result in significant voltage rises due to any series inductance resulting from long, indirect paths, or sharp bends in the routing of ground conductors. This is why short, direct ground connections are important.

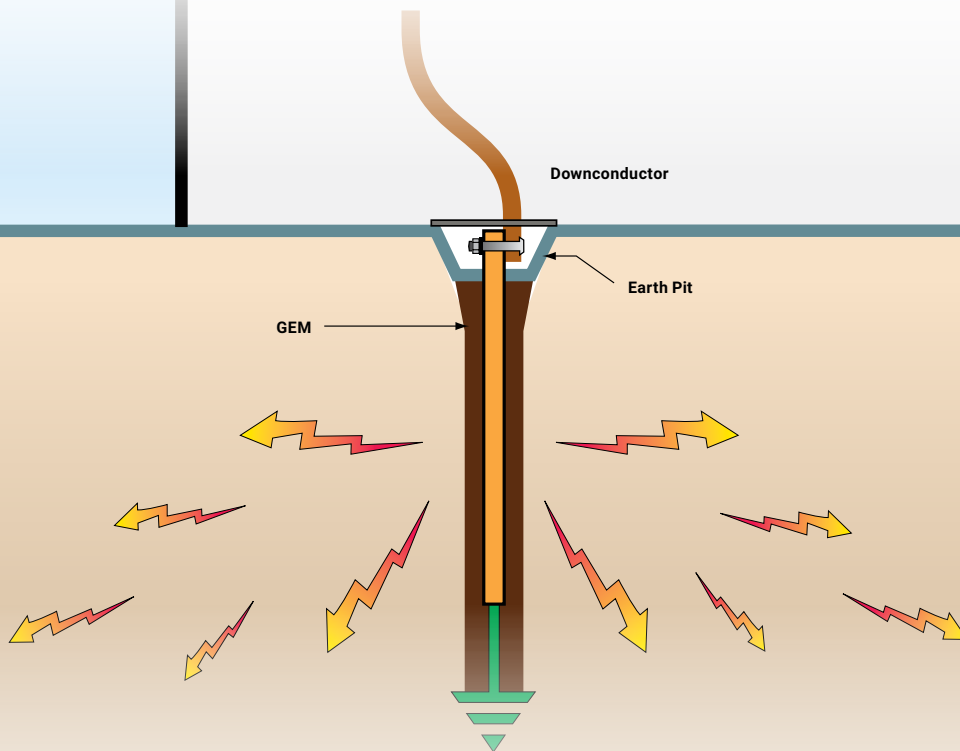

Earthing Principles

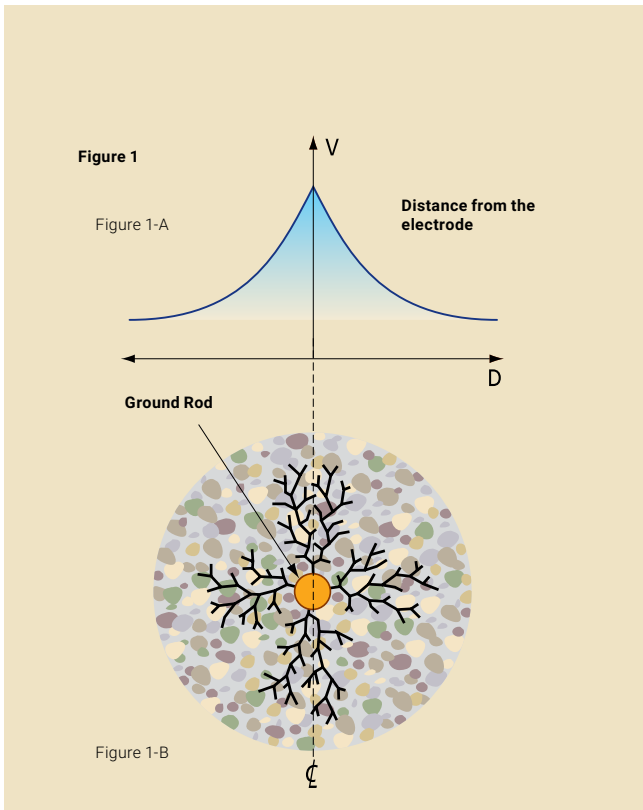

Figure 1: illustrates current flow from a single earth electrode. The current paths are shown in Figure 1-B. Figure 1-A illustrates the voltage gradient that is produced as a result of this current flow. This gradient levels off at some distance from the earth electrode. The voltage gradients are determined by the earth electrode impedance and the soil resistivity.

Characteristics of good earthing systems include:

- **High electrical conductivity**
- **Long life – robust and capable of withstanding fault and lightning currents**
- **Low ground resistance and impedance**

High electrical conductivity helps minimize system impedance and reduces potential differences between bonded metallic water services, power systems, telecommunication systems and the earth reference point. High electrical conductivity also minimizes step and touch potential in substation earthing applications.

LONG LIFE

The earth electrode system should be corrosion resistant, and compatible with other conductors that are buried and bonded to the earthing system. Copper is commonly used for earthing conductors. When accessible, some form of maintenance or inspection procedure should be adopted to ensure the long-term effectiveness of an earthing system.

Mechanical connectors are sometimes used to join earthing conductors, however they are more susceptible to corrosion, especially when dissimilar metals are used. In addition to mechanical strength, Cadweld connections provide excellent low impedance, long life electrical connections with excellent corrosion resistance.

GROUND RESISTANCE

When current flows from an earth electrode into the surrounding soil, it can be described as flowing through a series of concentric shells of increasing diameter.

Each successive shell has a greater area for current flow and consequently, lower resistance. At some point distant from the earth conductor the current dissipation becomes so large and current density so small, that the resistance becomes negligible.

The equations for systems of electrodes are very complex and often expressed only as approximations. For example uniform earth (or soil) resistivity is assumed, although this is seldom the case in nature. The most commonly used formula for single ground electrode systems, developed by Professor H.R. Dwight of the Massachusetts Institute of Technology, is the following:

$$R = \frac{\rho}{2\pi L} \left\{ (\ln \frac{4L}{r}) - 1 \right\}$$

R = resistance in ohms of the ground rod to the earth (or soil)

L = grounding electrode length

r = grounding electrode radius

ρ = average resistivity in ohms-cm.

Earthing Principles

CONDITIONS INFLUENCING SOIL RESISTIVITY

The resistance of the earth itself (soil resistivity) can significantly impact the overall impedance of the grounding system. Several factors, such as soil composition, moisture content, mineral content, contaminants, etc., determine the overall resistivity of the earth.

SOIL TYPE	Resistivity ohm-cm		
	Average	Min.	Max.
Fills – ashes, cinders, brine wastes	2,370	590	7,000
Clay, shale, gumbo, loam	4,060	340	16,300
Clay, shale, gumbo, loam with varying proportions of sand and gravel	15,800	1,020	135,000
Gravel, sand, stones, with little clay or loam	94,000	59,000	458,000

U.S. Bureau of Standards Technical Report 108

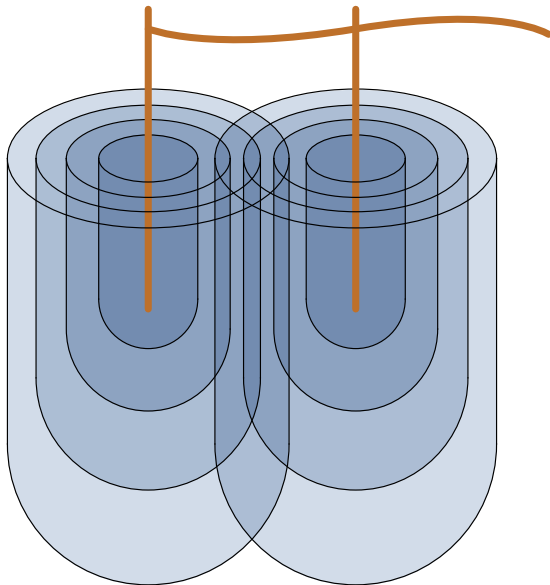

Sphere of Influence - parallel earth electrodes need to be properly spaced to minimize ground resistance due to sphere of influence. The distance between earth electrodes should be greater than or equal to the length of the electrodes.

SOIL RESISTIVITY TESTING

To properly design a grounding system, it is essential to test soil resistivity. There are a few methods that can be used to measure earth resistivity. The four point method is the most common and accurate and the one that nVent recommends.

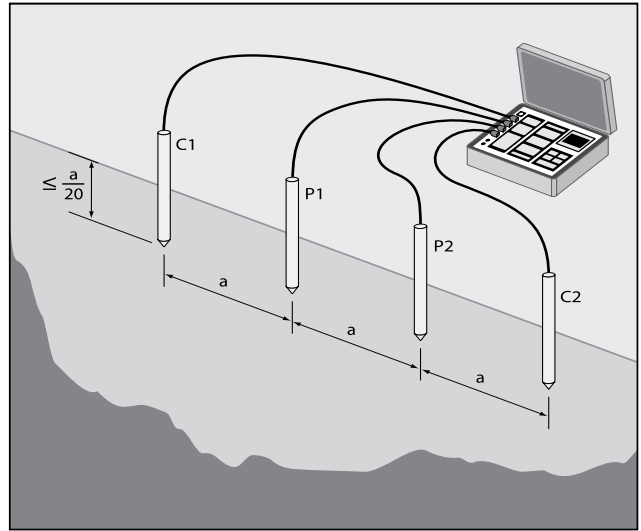

THE FOUR-POINT METHOD (EQUALLY SPACED OR WENNER METHOD)

1. Four test stakes are positioned in a straight line an equal distance apart and are installed into the ground as shown in Figure 2.
2. A resistance tester is connected as shown in Figure 2. A test current is passed between the outer probes, C1 and C2, and the voltage is measured between the two inner probes, P1 and P2.
3. With this arrangement the apparent resistivity is determined using the following equation:

R = the resistance value in ohms, measured from the test instrument

$$\rho = \frac{4\pi aR}{\frac{1+2a}{\sqrt{a^2+4b^2}} - \frac{2a}{\sqrt{a^2+4b^2}}}$$

Where:

a = distance between the electrodes in centimeters

b = electrode depth in centimeters

If $a > 20b$, the formula can be simplified to:

$$\rho = 2\pi aR \text{ (with } a \text{ in cm)}$$

ρ = Soil resistivity (ohm-cm)

This value is average resistivity of the ground at a depth equivalent to the distance "a" between two electrodes.

Earthing Principles



Avoid hazardous Step and Touch Potentials (shock) or even death by low impedance grounding and bonding between metallic equipment, chassis, piping, and other conductive objects so that currents, due to faults, do not result in hazardous voltage rise.

STEP AND TOUCH POTENTIAL

STEP POTENTIAL

Step potential is the voltage difference between a person's feet caused by the dissipation gradient of a fault entering the earth.

TOUCH POTENTIAL

Touch potential is similar to "Step potential" except that the fault current passes through the person's arm and torso on the way to the ground.

With proper installation of grounding systems these step and touch potentials can be minimized to a safe level.

See IEEE Std 80, IEEE Guide for Safety in AC Substation Grounding.

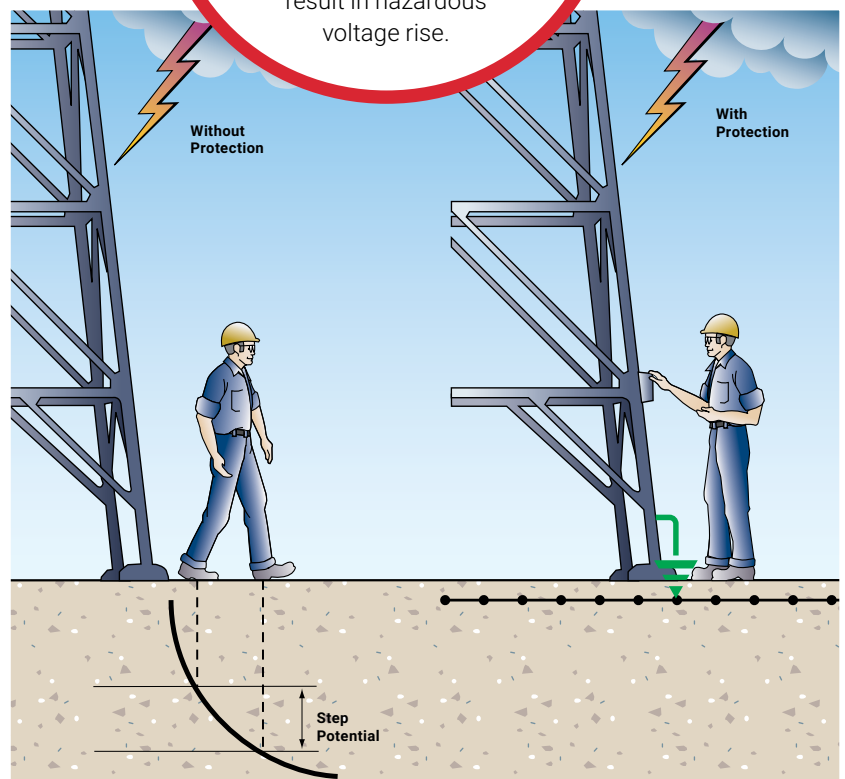

Earthing Principles

GROUNDING/EARTHING SYSTEM DESIGN

Earthing systems are important. It is far more economical to design and install an appropriate earthing system during initial construction than it is to expand, augment or replace an earthing system after the facility is in service. Care should be taken to design a system that is appropriate both for clearing earth faults and dissipating lightning energy. The system must have a long performance life, meet applicable codes/standards for safety, and have sufficient bonding points to make it easy to expand the earthing system for future growth.

DESIGN CONSIDERATIONS INCLUDE:

- Purpose of facility
- Design life of facility
- Soil resistivity
- Corrosive nature of soil
- Shape and available area of facility site
- Existing structures and their grounding systems
- Seasonal variations in moisture and temperature for facility site
- Public access & personnel use
- Adjacent facilities and electrical systems
- Future uses, additions, equipment for facility

For proper operation of overcurrent devices it is important to have a low impedance path for the return current.

For dissipation of direct or indirect lightning currents, it is better to have many horizontal ground conductors in the soil, preferably in a radial array. This provides a low impedance path of dissipation to the high frequency component of the lightning energy.

For personnel, particularly where equipment operators will be located or where accessible by the public, it is important to have a grid system or other equipotential plane to reduce "step potential" and have equipment and metal structures bonded to the earth system to reduce "touch potential".

A proper facility earthing system incorporates these necessities in the most cost-effective manner that will last for the design life of the facility.

nVent is a manufacturer and marketer of earthing, bonding, lightning protection and surge protection products and systems under the nVent ERICO sub-brand. nVent ERICO has many knowledgeable and experienced engineers on staff with the training and the tools (including some of the latest design software) to design appropriate earthing systems. These engineers can assist facility owners, engineers and contractors in designing the most appropriate system for the facility in question.



Earthing Principles

THE EARTHING CHAIN

The performance of the earthing system is determined by the quality of the following five components all of which are of equal importance.

1. The Earthing Electrode Conductor. Commonly made from copper or copper-bonded steel, the earthing electrode conductor must be large enough to withstand the maximum available fault current over the maximum clearing time.
2. The Earthing Connections. Often overlooked, the earthing connections are used to tie the elements of the electrode system together. Exothermically welded connections provide a molecular bond that will never loosen or corrode. Mechanical connectors, such as crimp, bolted, and wedge type, rely on physical point-to-point surface contact to maintain the integrity of the electrical connection. IEEE® Standard 837-2014 provides detailed information on the application and testing of permanent grounding connections. nVent ERICO can provide an independent, third-party test report evaluating the performance of these connectors in accordance with the testing procedures set forth in IEEE Standard 837-2014, Standard for Qualifying Permanent Substation Grounding Connections.
3. The Earthing Electrode. The earthing electrode provides the physical connection to the earth and is used to dissipate current into it. There are two main types of electrodes. "Natural" electrodes are intrinsic to the facility and include metal underground water pipe, the metal frame of the building, and reinforcing steel in concrete foundations. "Made" electrodes are installed specifically to improve the performance of the earthing system and include wire meshes, metallic plates, buried conductor and rods or pipes driven into the ground. The ground rod is the most widely used electrode.
4. Electrode to Soil Resistance. Rod surface area, depth and placement are the controlling factors. Doubling diameter reduces resistance by only 10% and is not cost effective. Doubling rod length, however, theoretically reduces resistance up to 40%. The most common solution is proper placement of multiple rods that are driven to the required depths.
5. The Soil. The soil resistivity, measured in ohm-centimeters or ohm-meters, plays the most significant role in determining the overall performance of the grounding system and must be known before a proper grounding system can be engineered.



The earthing system will carry little or no current for long periods of time until a fault or lightning strike occurs. When this happens the components will conduct a large amount of current and should be expected to perform like new. Most of the earthing system is concealed below grade, making inspection of the grounding components difficult or impossible. The underground environment is a harsh one. The initial selection of the components used in the grounding system is of critical importance to its long-term effectiveness.

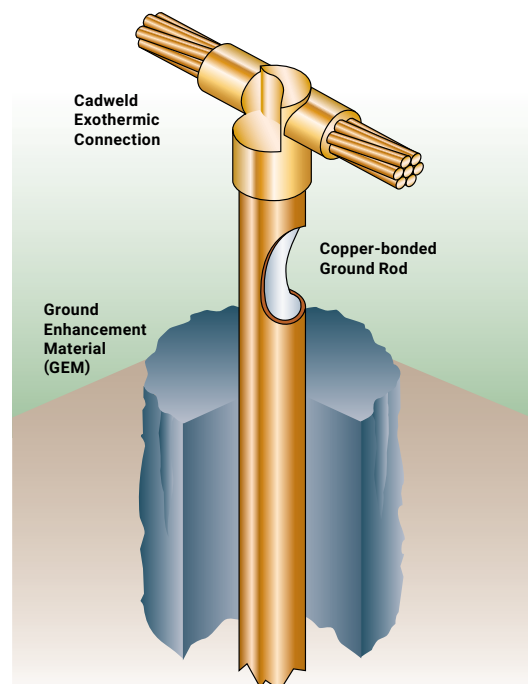

Ground Rods and Accessories

COPPER-BONDED GROUND ROD, POINTED

FEATURE

- 99.9% pure electrolytic copper coating
- Molecular bond to nickel-sealed high strength steel core
- Rods have a high carbon steel core and tip that provide superior strength when driving
- Copper coating will not crack when bent or tear when driven
- Minimum copper coating of 10 mils on rods listed to UL® 467
- nVent ERICO name, length, diameter and part number is roll-stamped within 12" (304,8 mm) of chamfered end
- UL logo and control number where applicable stamped on each rod for easy inspection after installation

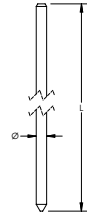

Material: Copper-Bonded Steel
Tensile Strength: 552 MPa Min



Part Number	Ground Rod Diameter, Nominal	Ground Rod Diameter, Actual	Length	Plating Thickness	Unit Weight	UPC Label	Complies With	Certifications
613840	3/8"	9.0 mm	1.2 m	254 µm	0.570 kg	No		
613850	3/8"	9.0 mm	1.5 m	254 µm	0.730 kg	No		
613860	3/8"	9.0 mm	1.8 m	254 µm	0.900 kg	No		
613870	3/8"	9.0 mm	2.1 m	254 µm	1.076 kg	No		
613880	3/8"	9.0 mm	2.4 m	254 µm	1.230 kg	No		
611330	1/2"	12.7 mm	0.9 m	254 µm	0.980 kg	No		
6113330	1/2"	12.7 mm	1.0 m	254 µm	1.003 kg	No	IEC® EN 62561-2	
611340	1/2"	12.7 mm	1.2 m	254 µm	1.260 kg	No		
611350	1/2"	12.7 mm	1.5 m	254 µm	1.570 kg	No		
611353	1/2"	12.7 mm	1.5 m	330 µm	1.670 kg	No		
611360	1/2"	12.7 mm	1.8 m	254 µm	2.010 kg	No		
611370	1/2"	12.7 mm	2.1 m	254 µm	2.108 kg	No	IEC® EN 62561-2	
611380	1/2"	12.7 mm	2.4 m	254 µm	2.510 kg	No	ANSI®/NEMA® GR1	UL
611300	1/2"	12.7 mm	3.0 m	254 µm	3.110 kg	No	ANSI®/NEMA® GR1	CSA, cULus
611303	1/2"	12.7 mm	3.0 m	330 µm	3.350 kg	No	ANSI®/NEMA® GR1	cULus
615830	5/8"	14.2 mm	0.9 m	254 µm	1.130 kg	No	IEC® EN 62561-2	
6158330	5/8"	14.2 mm	1.0 m	254 µm	1.237 kg	No	IEC® EN 62561-2	
615840	5/8"	14.2 mm	1.2 m	254 µm	1.540 kg	No	IEC® EN 62561-2	
615843	5/8"	14.2 mm	1.2 m	330 µm	1.540 kg	No	IEC® EN 62561-2	
615850	5/8"	14.2 mm	1.5 m	254 µm	1.920 kg	No	IEC® EN 62561-2	
615853	5/8"	14.2 mm	1.5 m	330 µm	2.040 kg	No	IEC® EN 62561-2	
615860	5/8"	14.2 mm	1.8 m	254 µm	2.300 kg	No	IEC® EN 62561-2	
615863	5/8"	14.2 mm	1.8 m	330 µm	2.450 kg	No	IEC® EN 62561-2	
6158660	5/8"	14.2 mm	2.0 m	254 µm	2.477 kg	No	IEC® EN 62561-2	
615870	5/8"	14.2 mm	2.1 m	254 µm	2.600 kg	No		
615880	5/8"	14.2 mm	2.4 m	254 µm	3.070 kg	No	IEC® EN 62561-2, ANSI®/NEMA® GR1	UL
615883	5/8"	14.2 mm	2.4 m	330 µm	3.080 kg	No	IEC® EN 62561-2, ANSI®/NEMA® GR1	UL
615800	5/8"	14.2 mm	3.0 m	254 µm	3.850 kg	No	IEC® EN 62561-2, ANSI®/NEMA® GR1	CSA, cULus

Part Number	Ground Rod Diameter, Nominal	Ground Rod Diameter, Actual	Length	Plating Thickness	Unit Weight	UPC Label	Complies With	Certifications
615803	5/8"	14.2 mm	3.0 m	330 µm	3.830 kg	No	IEC® EN 62561-2, ANSI®/NEMA® GR1	cULus
615812	5/8"	14.2 mm	3.7 m	254 µm	4.540 kg	No	IEC® EN 62561-2, ANSI®/NEMA® GR1	cULus
615815	5/8"	14.2 mm	4.6 m	254 µm	5.780 kg	No	IEC® EN 62561-2, ANSI®/NEMA® GR1	cULus
615950	5/8"	16.0 mm	1.5 m	254 µm	2.350 kg	No		
615980	5/8"	16.0 mm	2.4 m	254 µm	3.870 kg	No	IEC® EN 62561-2, ANSI®/NEMA® GR1	UL
615900	5/8"	16.0 mm	3.0 m	254 µm	4.760 kg	No	IEC® EN 62561-2, ANSI®/NEMA® GR1	cULus
613440	3/4"	17.3 mm	1.2 m	254 µm	2.550 kg	No	IEC® EN 62561-2	
613450	3/4"	17.3 mm	1.5 m	254 µm	2.810 kg	No	IEC® EN 62561-2	
613460	3/4"	17.3 mm	1.8 m	254 µm	3.400 kg	No	IEC® EN 62561-2	
613470	3/4"	17.3 mm	2.1 m	254 µm	3.835 kg	No	IEC® EN 62561-2	
613480	3/4"	17.3 mm	2.4 m	254 µm	4.560 kg	No	IEC® EN 62561-2, ANSI®/NEMA® GR1	UL
613483	3/4"	17.3 mm	2.4 m	330 µm	4.540 kg	No	IEC® EN 62561-2, ANSI®/NEMA® GR1	UL
613400	3/4"	17.3 mm	3.0 m	254 µm	5.720 kg	No	IEC® EN 62561-2, ANSI®/NEMA® GR1	CSA, cULus
613403	3/4"	17.3 mm	3.0 m	330 µm	5.630 kg	No	IEC® EN 62561-2, ANSI®/NEMA® GR1	cULus
613412	3/4"	17.3 mm	3.7 m	254 µm	6.770 kg	No	IEC® EN 62561-2, ANSI®/NEMA® GR1	cULus
613415	3/4"	17.3 mm	4.6 m	254 µm	8.390 kg	No	IEC® EN 62561-2, ANSI®/NEMA® GR1	cULus
693400	3/4"	19.1 mm	3.0 m	254 µm	5.600 kg	No	IEC® EN 62561-2, ANSI®/NEMA® GR1	cULus
693450	3/4"	19.1 mm	1.5 m	254 µm	2.800 kg	No		
614400	1"	23.2 mm	3.0 m	254 µm	10.000 kg	No	ANSI®/NEMA® GR1	CSA, cULus

For rods to be listed to UL® 467, they must be at least 8' (2.43 m) in length.
IEC® EN 62561-2 supercedes EN 50164-2.
Additional lengths available.

COMPRESSION COUPLER FOR COPPER-BONDED GROUND ROD, POINTED

FEATURE

- Threadless compression coupler for use with pointed copper-bonded ground rods
- Inside of coupler is tapered so ground rod compresses during installation to form an irreversible conductive connection

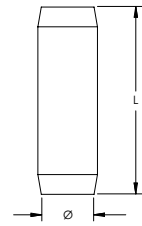

Part Number	Article Number	Ground Rod Diameter, Nominal	Length	Unit Weight	Complies With	Certifications
Material: Brass						
156650	156650	1/2"	70.0 mm	0.13 kg		
Material: Silicon Bronze						
CC12F	158000	1/2"	69.8 mm	0.13 kg		CSA, cULus
CC58	158010	5/8"	69.8 mm	0.15 kg	IEC® EN 62561-2	CSA, cULus
CC34	158020	3/4"	69.8 mm	0.20 kg	IEC® EN 62561-2	CSA, cULus

IEC® EN 62561-2 supercedes EN 50164-2.

COPPER-BONDED GROUND ROD, THREADED

FEATURE

- Cold-rolled threads with continuous, unbroken grain flows preserve copper coating and are stronger than cut threads
- 99.9% pure electrolytic copper coating
- Molecular bond to nickel-sealed high strength steel core
- Rods have a high carbon steel core and tip that provide superior strength when driving
- Copper coating will not crack when bent or tear when driven
- Minimum copper coating of 10 mils on rods listed to UL® 467
- nVent ERICO name, length, diameter and part number is roll-stamped within 12" (304,8 mm) of chamfered end
- UL logo and control number where applicable stamped on each rod for easy inspection after installation

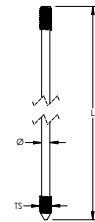

Material: Copper-Bonded Steel
Tensile Strength: 552 MPa Min
Thread Location: Pointed and Chamfered Ends



Part Number	Ground Rod Diameter, Nominal	Ground Rod Diameter, Actual	Thread Size	Length	Plating Thickness	Unit Weight	Complies With	Certifications
631340	1/2"	12.8 mm	9/16 UNC	1.2 m	254 µm	1.200 kg		
631350	1/2"	12.8 mm	9/16 UNC	1.5 m	254 µm	1.600 kg		
631360	1/2"	12.8 mm	9/16 UNC	1.8 m	254 µm	1.900 kg		
631380	1/2"	12.8 mm	9/16 UNC	2.4 m	254 µm	2.400 kg	ANSI®/NEMA® GR1	UL
631300	1/2"	12.8 mm	9/16 UNC	3.0 m	254 µm	3.100 kg	ANSI®/NEMA® GR1	CSA, cULus
631303	1/2"	12.8 mm	9/16 UNC	3.0 m	330 µm	3.200 kg	ANSI®/NEMA® GR1	cULus

Part Number	Ground Rod Diameter, Nominal	Ground Rod Diameter, Actual	Thread Size	Length	Plating Thickness	Unit Weight	Complies With	Certifications
635830	5/8"	14.2 mm	5/8 UNC	0.9 m	254 µm	1.200 kg	IEC® EN 62561-2	
635840	5/8"	14.2 mm	5/8 UNC	1.2 m	254 µm	1.500 kg	IEC® EN 62561-2	
635843	5/8"	14.2 mm	5/8 UNC	1.2 m	330 µm	1.500 kg	IEC® EN 62561-2	
635850	5/8"	14.2 mm	5/8 UNC	1.5 m	254 µm	1.900 kg	IEC® EN 62561-2	
635860	5/8"	14.2 mm	5/8 UNC	1.8 m	254 µm	2.300 kg	IEC® EN 62561-2	
6358660	5/8"	14.2 mm	5/8 UNC	2.0 m	254 µm	2.484 kg	IEC® EN 62561-2	
635870	5/8"	14.2 mm	5/8 UNC	2.1 m	254 µm	2.900 kg	IEC® EN 62561-2	
635880	5/8"	14.2 mm	5/8 UNC	2.4 m	254 µm	3.000 kg	ANSI®/NEMA® GR1, IEC® EN 62561-2	UL
635883	5/8"	14.2 mm	5/8 UNC	2.4 m	330 µm	3.000 kg	ANSI®/NEMA® GR1, IEC® EN 62561-2	UL
635800	5/8"	14.2 mm	5/8 UNC	3.0 m	254 µm	3.800 kg	ANSI®/NEMA® GR1, IEC® EN 62561-2	CSA, cULus
635803	5/8"	14.2 mm	5/8 UNC	3.0 m	330 µm	3.900 kg	ANSI®/NEMA® GR1, IEC® EN 62561-2	cULus
633430	3/4"	17.3 mm	3/4 UNC	0.9 m	254 µm	1.700 kg	IEC® EN 62561-2	
6334330	3/4"	17.3 mm	3/4 UNC	1.0 m	254 µm	2.793 kg	IEC® EN 62561-2	
633440	3/4"	17.3 mm	3/4 UNC	1.2 m	254 µm	2.200 kg	IEC® EN 62561-2	
633450	3/4"	17.3 mm	3/4 UNC	1.5 m	254 µm	2.800 kg	IEC® EN 62561-2	
633460	3/4"	17.3 mm	3/4 UNC	1.8 m	254 µm	3.200 kg	IEC® EN 62561-2	
633463	3/4"	17.3 mm	3/4 UNC	1.8 m	330 µm	3.200 kg	IEC® EN 62561-2	
633470	3/4"	17.3 mm	3/4 UNC	2.1 m	254 µm	3.900 kg	IEC® EN 62561-2	
633480	3/4"	17.3 mm	3/4 UNC	2.4 m	254 µm	4.400 kg	ANSI®/NEMA® GR1, IEC® EN 62561-2	UL
633400	3/4"	17.3 mm	3/4 UNC	3.0 m	254 µm	5.700 kg	ANSI®/NEMA® GR1, IEC® EN 62561-2	CSA, cULus
633403	3/4"	17.3 mm	3/4 UNC	3.0 m	330 µm	5.700 kg	ANSI®/NEMA® GR1, IEC® EN 62561-2	cULus
633415	3/4"	17.3 mm	3/4 UNC	4.6 m	254 µm	8.500 kg	ANSI®/NEMA® GR1, IEC® EN 62561-2	cULus
634400	1"	23.2 mm	1 UNC	3.0 m	254 µm	10.000 kg	ANSI®/NEMA® GR1	CSA, cULus

For rods to be listed to UL® 467, they must be at least 8' (2.43 m) in length.
IEC® EN 62561-2 supercedes EN 50164-2.

THREADED COUPLER FOR COPPER-BONDED GROUND ROD, THREADED

FEATURE

- High-strength couplings are threaded and chamfered at both ends for easy driving
- Corrosion-resistant couplings ensure permanent, low resistance copper-to-copper connections

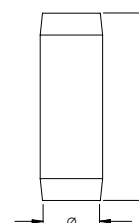

Part Number	Article Number	Ground Rod Diameter, Nominal	Length	Thread Size	Unit Weight	Complies With	Certifications
Material: Bronze							
CR58	158040	5/8"	61.0 mm	5/8 UNC	0.10 kg	IEC® EN 62561-2	CSA, cULus
SC34	158050	3/4"	71.0 mm	3/4 UNC	0.17 kg	IEC® EN 62561-2	

Part Number	Article Number	Ground Rod Diameter, Nominal	Length	Thread Size	Unit Weight	Complies With	Certifications
CR34	-	3/4"	76.2 mm	3/4 UNC	0.15 kg		CSA, cULus
Material: Silicon Bronze							
CR100	-	1"	99.1 mm	1 UNC	0.35 kg		cULus

GROUND ROD DRIVING STUD FOR THREADED GROUND RODS

FEATURE

- Used in conjunction with threaded couplers while driving threaded ground rods

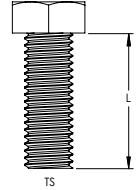

Material: Steel

Part Number	Ground Rod Diameter, Nominal	Thread Size	Length
710090	3/8"	M10	18.0 mm
710100	3/8"	M10	21.0 mm
DS12	1/2"	1/2 UNC	38.1 mm
158100	5/8"	5/8 UNC	31.8 mm
DS58	5/8"	5/8 UNC	44.5 mm
158110	3/4"	3/4 UNC	38.1 mm
DS34	3/4"	3/4 UNC	50.8 mm

GROUND ROD DRIVING POINT FOR THREADED GROUND RODS

FEATURE

- Threaded ground rod driving tip to assist in driving threaded ground rods into the earth

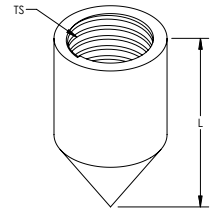

Material: Steel

Part Number	Ground Rod Diameter, Nominal	Thread Size	Length
SDT34	3/4"	3/4 UNC	42 mm
SDT58	5/8"	5/8 UNC	42 mm

GALVANIZED GROUND ROD, POINTED

FEATURE

- Meets ANSI®/NEMA® GR1
- Zinc-coated exteriors are hot-dip galvanized for solid protection against corrosion, in accordance with ASTM® specification A123
- Surfaces are rigidly inspected to eliminate seams, slivers and other defects

Material: Steel
Finish: Hot-Dip Galvanized
Tensile Strength: 552 MPa Min

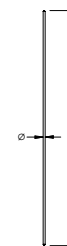
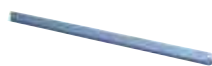

Part Number	Ground Rod Diameter, Nominal	Ground Rod Diameter, Actual	Length	Unit Weight	UPC Label
815800	5/8"	16 mm	3.05 m	4.8 kg	No

STAINLESS STEEL GROUND ROD, SECTIONAL INTERNAL THREAD

FEATURE

- Stainless steel sectional ground rod with internal threading

Material: Stainless Steel 316 (EN 1.4401)
Tensile Strength: 483 MPa Min

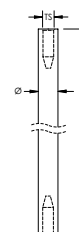

Part Number	Article Number	Ground Rod Diameter, Actual	Thread Size	Length	Unit Weight
SSR16	710010	16 mm	M10	1.2 m	1.8 kg

THREADED COUPLER FOR STAINLESS STEEL GROUND ROD, INTERNAL THREAD

FEATURE

- For use with SSR16 stainless steel ground rod, sectional internal thread

Material: Stainless Steel 304 (EN 1.4301)

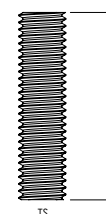
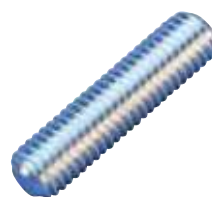

Part Number	Article Number	Length	Thread Size	Unit Weight
SSD10	710115	40 mm	M10	0.02 kg

SOLID COPPER GROUND ROD, POINTED

FEATURE

- Solid copper ground rods made of high conductive hard drawn bare copper

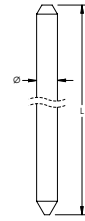

Material: Copper
Tensile Strength: 290 MPa Min



Part Number	Ground Rod Diameter, Nominal	Ground Rod Diameter, Actual	Length	Unit Weight
LPC706	5/8"	15.9 mm	3.05 m	5.35 kg
LPC711	3/4"	19.1 mm	3.05 m	7.70 kg

Due to the inherent softness of the copper material, special consideration should be given when driving this product into the soil.

SOLID COPPER GROUND ROD, SECTIONAL INTERNAL THREAD

FEATURE

- Solid copper sectional ground rod with internal threading

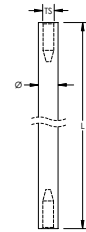

Material: Copper
Tensile Strength: 50 MPa

Part Number	Article Number	Ground Rod Diameter, Actual	Thread Size	Length	Unit Weight
SCR15	710070	15 mm	M10	1.2 m	1.64 kg
SCR20	710080	20 mm	M10	1.2 m	3.34 kg

Due to the inherent softness of the copper material, special consideration should be given when driving this product into the soil.

THREADED COUPLER FOR SOLID COPPER GROUND ROD, INTERNAL THREAD

FEATURE

- Internal coupling for SCR15 and SCR20 copper ground rods

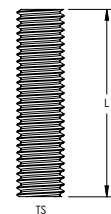

Material: Phosphor Bronze

Part Number	Length	Thread Size	Unit Weight
PBD10	40 mm	M10	0.02 kg

CHEMICAL GROUND ELECTRODE

FEATURES

- Contains natural electrolytic salts, which permeate into the surrounding soil to condition the soil and increase its conductivity
- Easy connection to ground electrode conductor using the factory provided pigtail (up or down orientation)
- Provides decades of reliable services due to rugged construction and high-quality metals with a 30-year minimum service life
- 2-1/8" (54 mm) outside diameter copper pipe with 0.083" (2.1 mm) wall
- Available in continuous sections up to 10' (3.05 m) in length; longer rods can be field assembled using 5' (1.52 m) or 10' (3.05 m) extensions
- Optional factory-attached radial strips are available to reduce impedance to high-frequency lightning energy and to control the direction of the dissipation
- L-shaped rods are available for horizontal installation applications where it is impractical to auger deep vertical holes
- Access segment on horizontal (L-shaped) chemical ground electrodes is 32" (813 mm) deep



Chemical ground electrodes provide a low impedance ground in locations of high soil resistivity and dry soil conditions. Used in conjunction with a bentonite backfill and nVent ERICO's unique GEM material, the nVent ERICO chemical ground rod electrode systems provide a method to improve soil resistivity directly surrounding the electrode, and can replace multiple conventional ground rods. It maintains a low ground resistance, maintenance-free installation that dissipates lightning energy and other dangerous electrical fault currents, even in sandy or rocky soil conditions. The chemical ground electrode is useful for providing an effective earth in poor soil conditions where space for electrodes is limited. Applications include telecommunications, power generation and distribution, commercial and industrial, manufacturing, transportation (rail and aviation), lightning protection, recreational facilities, and defense. The nVent ERICO chemical ground rod electrode systems are most effective when installed as part of a total system that includes high conductivity backfill materials, access/inspection wells, and permanent, reliable nVent ERICO Cadweld connections. They may be installed either vertically or horizontally.

Material: Copper



ECR V 10 2Q 4 U B

ECR	ERICO Chemical Ground Electrode System	
V	Installation	H: Horizontal HE: Horizontal Extended V: Vertical E: Vertical Extended
10	Electrode Length (')	
2Q	Cable Size	1G: #6 Sol, 1L: #4 Str, 1T: #2 Sol, 1V: #2 Str 2C: 1/0 Str, 2G: 2/0 Str, 2K: 3/0 Sol, 2L: 3/0 Str, 2Q: 4/0 Str 2V: 250 kcmil Str, 3D: 350 kcmil Str, 3Q: 500 kcmil Str, 4L: 750 kcmil Str
4	Pigtail Length (')	
U	Pigtail Orientation	U: Up, D: Down
B*	Rod assembly only	Add "B" for rod assembly only. Leave blank for kit.

* Empty if none

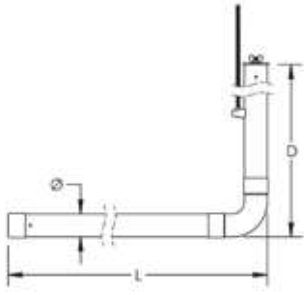

Horizontal with Pigtail Up

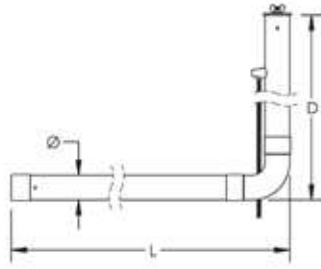

Horizontal with Pigtail Down



Vertical with Pigtail Up

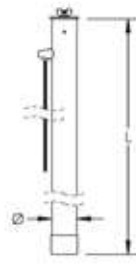

Vertical with Pigtail Down

Part Number	Electrode Length	Pigtail Length	Depth	Conductor Size	Kit
Installation: Horizontal with Pigtail Up					
ECRH082C4U	2.4 m	1.2 m	813 mm	1/0 Stranded	Yes
ECRH101T4U	3.1 m	1.2 m	813 mm	#2 Solid	Yes
ECRH102C4U	3.1 m	1.2 m	813 mm	1/0 Stranded	Yes
ECRH102G4U	3.1 m	1.2 m	813 mm	2/0 Stranded	Yes
ECRH101T5U	3.1 m	1.5 m	813 mm	#2 Solid	Yes
Installation: Horizontal with Pigtail Down					
ECRH101T4DB	3.1 m	1.2 m	813 mm	#2 Solid	No
ECRH101T4D	3.1 m	1.2 m	813 mm	#2 Solid	Yes
ECRH102C4D	3.1 m	1.2 m	813 mm	1/0 Stranded	Yes
ECRH102G4D	3.1 m	1.2 m	813 mm	2/0 Stranded	Yes
Installation: Vertical with Pigtail Up					
ECRV101T2U	3.1 m	0.6 m	–	#2 Solid	Yes
ECRV101T4U	3.1 m	1.2 m	–	#2 Solid	Yes
ECRV102C4U	3.1 m	1.2 m	–	1/0 Stranded	Yes
ECRV102V4U	3.1 m	1.2 m	–	250 kcmil Stranded	Yes
ECRV102Q5U	3.1 m	1.5 m	–	4/0 Stranded	Yes
ECRV122Q4U	3.7 m	1.2 m	–	4/0 Stranded	Yes
ECRE152Q4U	4.6 m	1.2 m	–	4/0 Stranded	Yes
ECRE201T4U	6.1 m	1.2 m	–	#2 Solid	Yes
ECRE202G4U	6.1 m	1.2 m	–	2/0 Stranded	Yes
ECRE352L1UB	10.7 m	0.3 m	–	3/0 Stranded	No
Installation: Vertical with Pigtail Down					
ECRV102Q4DB	3.1 m	1.2 m	–	4/0 Stranded	No
ECRE102Q4D	3.1 m	1.2 m	–	4/0 Stranded	Yes
ECRE202C4DB	6.1 m	1.2 m	–	1/0 Stranded	No
ECRE202C4D	6.1 m	1.2 m	–	1/0 Stranded	Yes

CHEMICAL GROUND ELECTRODE SALT MIX

FEATURE

- Individual packages of salt mix are available for sale separately from the chemical ground rod assembly



Part Number	Unit Weight
ECRCHM15LB	6.8 kg

NVENT ERICO HAMMERLOCK GROUND CLAMP

FEATURE

- Irreversible connection with excellent mechanical strength
- Fast and simple installation requires only a hammer
- No special training required
- Low resistance connection
- Provides a visual indication of completed connection
- Allows for "T" or pass-through connections

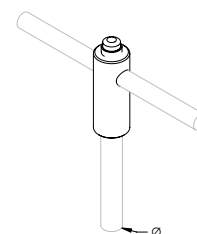

Ground Rod Type: Copper-bonded
Material: Copper



Part Number	Article Number	Ground Rod Diameter, Nominal	Ground Rod Diameter, Actual	Conductor Size	Number of Conductors	Certifications
EHL12FC1K	166958	1/2"	12.7 mm	#6 Solid - #4 Solid, 16 mm ² Stranded	1	cULus
EHL12FC1K1K	166959	1/2"	12.7 mm	#6 Solid - #4 Solid, 16 mm ² Stranded	2	
EHL12FC1V	166962	1/2"	12.7 mm	#4 Stranded - #2 Stranded, 25 mm ² Stranded	1	cULus
EHL12FC2G	-	1/2"	12.7 mm	1/0 Stranded - 2/0 Stranded	1	cULus
EHL58C1K	166973	5/8"	14.2 mm	#6 Solid - #4 Solid, 16 mm ² Stranded	1	cULus
EHL58C1K1K	166974	5/8"	14.2 mm	#6 Solid - #4 Solid, 16 mm ² Stranded	2	
EHL58C1V	166977	5/8"	14.2 mm	#4 Stranded - #2 Stranded, 25 mm ² Stranded	1	cULus
EHL58C2G	166978	5/8"	14.2 mm	1/0 Stranded - 2/0 Stranded	1	cULus
EHL34C1K	166988	3/4"	17.3 mm	#6 Solid - #4 Solid, 16 mm ² Stranded	1	cULus
EHL34C1V	166991	3/4"	17.3 mm	#4 Stranded - #2 Stranded, 25 mm ² Stranded	1	cULus
EHL34C2G	166992	3/4"	17.3 mm	1/0 Stranded - 2/0 Stranded	1	cULus

GROUND ROD CLAMP, ROD TO CONDUCTOR, BRONZE

FEATURE

- For use with copper-bonded ground rods
- Parts that are UL Listed are suitable for direct burial in earth or concrete

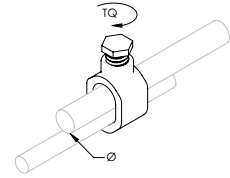

Part Number	Article Number	Ground Rod Diameter, Nominal	Ground Rod Diameter, Actual	Conductor Size	Wrench Size	Complies With	Certifications
Torque: 16.9 to 33.9 N-m – Material: Silicon Bronze							
CP38	158155	3/8"	9.7 mm	#10 Solid - #2 Stranded, 6 mm ² Solid - 25 mm ² Stranded	3/8"		cULus
CP58	158165	1/2" – 5/8"	12.5 – 14.2 mm	#10 Solid - #2 Stranded, 6 mm ² Solid - 25 mm ² Stranded	1/2"	IEC® EN 62561-1	CSA, cULus
CP34	158175	1/2" – 3/4"	12.5 – 17.3 mm	#10 Solid - 1/0 Stranded, 6 mm ² Solid - 50 mm ² Stranded	1/2"	IEC® EN 62561-1	CSA, cULus
Torque: 16.9 to 50.8 N-m – Material: Silicon Bronze							
HDC1	158250	1"	25.4 mm	#8 Solid - 4/0 Stranded, 10 mm ² Solid - 95 mm ² Stranded	9/16"		cULus
Torque: 25.0 N-m Max – Material: Gunmetal							
C12	158260	1/2" – 1/2"	12.5 – 12.7 mm	50 mm ² Stranded Max	14 mm		
C58	158160	1/2" – 5/8"	12.5 – 15.0 mm	70 mm ² Stranded Max	14 mm	IEC® EN 62561-1	
Torque: 33.9 N-m Max – Material: Gunmetal							
C34	158170	5/8" – 3/4"	14.2 – 17.2 mm	70 mm ² Stranded Max	14 mm	IEC® EN 62561-1	
C19	156900	5/8" – 3/4"	14.2 – 19.0 mm	70 mm ² Stranded Max	14 mm		
C200	156910	5/8" – 3/4"	14.2 – 20.0 mm	70 mm ² Stranded Max	24 mm		

GROUND ROD CLAMP, ROD TO CONDUCTOR, STAINLESS STEEL

FEATURE

- Unique stamped body design will not crack from excessive torque
- Provides a greater surface area contact to allow improved performance of the connector
- Compatible with copper, copper bonded, galvanized, stainless steel, rebar and plain steel ground rods and electrodes

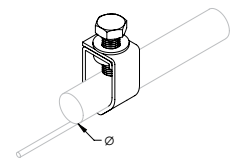

Material: Stainless Steel 304 (EN 1.4301)
Torque: 16.9 to 33.9 N-m



Part Number	Article Number	Ground Rod Diameter, Nominal	Ground Rod Diameter, Actual	Conductor Size	Wrench Size
SP58	158185	1/2" – 5/8"	12.7 – 15.9 mm	#10 Stranded - #2 Stranded, 6 mm ² Stranded - 25 mm ² Stranded	1/2"

GROUND ROD CLAMP, U-BOLT, TINNED, ONE CONDUCTOR

FEATURE

- Tinned finish provides a theft-deterrent appearance
- Accepts conductors in both parallel and perpendicular orientations

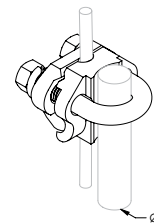
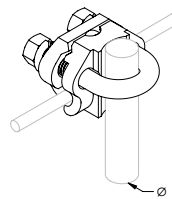

Material: Bronze, Stainless Steel 304 (EN 1.4301)
Finish: Tinned



Part Number	Ground Rod Diameter, Nominal	Conductor Size, UL
GC064	5/8" – 3/4"	#4 Sol - 2/0 Str, 16 mm ² Str - 50 mm ² Str
GC065	5/8" – 3/4"	2/0 Sol - 250 kcmil Str, 70 mm ² Str - 120 mm ² Str

GROUND ROD CLAMP, U-BOLT, THREE CONDUCTORS

FEATURE

- Ground rod clamp that allows up to three separate conductors to be connected to a ground rod
- Bronze material is a copper alloy with high copper content
- Tinned bronze has theft-deterrent appearance

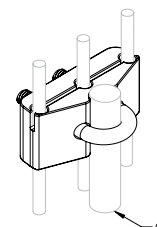

Material: Bronze
Finish: Tinned

Part Number	Ground Rod Diameter, Nominal	Ground Rod Diameter, Actual	Conductor Size
GC065TH	5/8" – 3/4"	15.9 – 19.1 mm	2/0 Solid - 250 kcmil Stranded, 70 mm ² Stranded - 120 mm ² Stranded

GROUND ROD CLAMP, U-BOLT, TYPE E

FEATURE

- Designed to accommodate tape or bar in either a horizontal or vertical position
- Can also be used with a lug connection from a round conductor
- Can be used to connect to ground rods or rebar

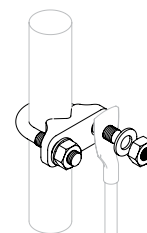
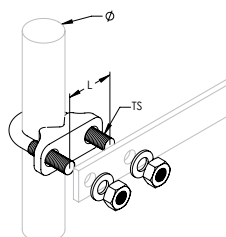

Material: Gunmetal, Brass

Part Number	Article Number	Ground Rod Diameter, Nominal	Ground Rod Diameter, Actual	Rebar Size, Metric	Rebar Size, US	Rebar Size, Canada	Length	Thread Size	Complies With
UB16	710370	5/8"	14.2 mm	12 mm	#4	10M	38 mm	M10	IEC® EN 62561-1
UB20	710380	3/4"	17.3 mm	16 mm	#5	15M	38 mm	M10	IEC® EN 62561-1
UB25	710390	1"	25.0 mm	25 mm	#8	25M	38 mm	M10	

GROUND ROD CLAMP, U-BOLT, BARE, ONE CONDUCTOR

FEATURE

- Accepts conductors in both parallel and perpendicular orientations
- For use with copper-bonded ground rods

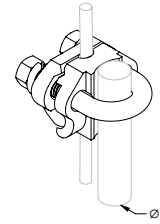
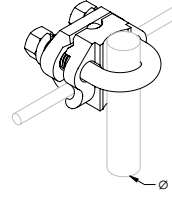

Material: Copper, Bronze, Brass

Part Number	Article Number	Ground Rod Diameter, Nominal	Ground Rod Diameter, Actual	Conductor Size	Complies With
GUV16070	710400	5/8" - 1"	14.2 - 23.2 mm	#4 Solid - 2/0 Stranded, 16 mm ² Stranded - 70 mm ² Stranded	IEC® EN 62561-1
GUV70185	710410	5/8" - 1"	14.2 - 23.2 mm	#4 Solid - 300 kcmil Stranded, 16 mm ² Stranded - 185 mm ² Stranded	IEC® EN 62561-1

GROUND ROD CLAMP WITH PREFABRICATED PIGTAIL

FEATURE

- Prefabricated assembly including grounding clamp with pigtail
- Fast and simple installation requires only a hammer

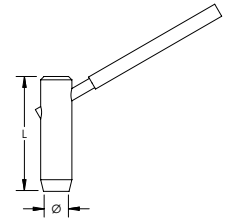

Material: Copper
Insulation: Green and Yellow Insulated Cable

Part Number	Article Number	Ground Rod Diameter, Nominal	Length	Pigtail Length	Conductor Size	Unit Weight
EPT1225300	158610	1/2"	70 mm	300 mm	25 mm ² Stranded	0.5 kg
EPT1425350	158675	5/8"	75 mm	350 mm	25 mm ² Stranded	0.5 kg
EPT1450350	158290	5/8"	75 mm	350 mm	50 mm ² Stranded	0.5 kg

GROUND ROD SPLIT CLAMP, ROD TO TAPE

FEATURE

- Used to connect a ground rod to a lug or to tape with a punched hole

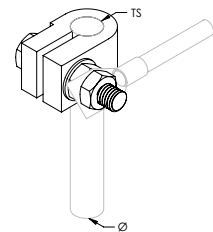

Material: Gunmetal

Part Number	Article Number	Ground Rod Diameter, Actual	Thread Size
RCC10	710420	9.2 mm Max	M8
RCC16	710430	14.2 mm Max	M10
SRC15	710440	14.8 mm Max	M10
SRC20	710450	19.0 mm Max	M12

GROUND ROD CLAMP

FEATURE

- Unique stamped body design will not crack as mechanical forces are increased
- Stainless steel threads will not strip if over-tightened
- Unique internal profile offers pull-out load in excess of four times the UL® 96 requirement
- Listed to UL® 96

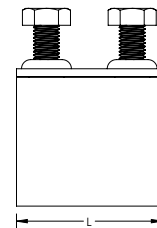
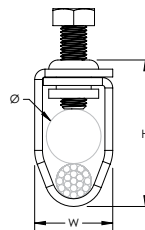

Material: Copper



Part Number	Conductor Size, UL	Ground Rod Diameter, Nominal	Ground Rod Diameter, Actual	Height	Length	Width	Unit Weight
LPC790	Class 1 - Class 2 (4/0 Max)	1/2" - 3/4"	12.7 - 17.3 mm	42 mm	44.5 mm	23.8 mm	0.152 kg

Connectors & Positioners

GROUNDING BUSBAR CONNECTOR, SOLID ROUND CONDUCTOR

FEATURE

- Used to connect solid round conductors, including ERICO-CU-BOND Round Conductor, to grounding busbars

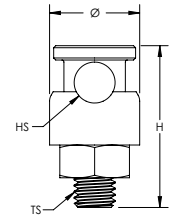

Material: Copper Alloy, Stainless Steel 18-8 (EN 1.4305)
Finish: Tinned

Part Number	Height	Diameter	Hole Size	Thread Size	nVent ERICO Cu-Bond Conductor	Complies With
BCR8T	50 mm	20 mm	9.5 mm	M10	CBSC8	IEC® 62561-1

IEC compliance is valid only for nVent ERICO Cu-Bond Conductors listed.

STAMPED BONDING PLATE

FEATURE

- Stamped bonding plate suitable for structural steel applications
- Listed to UL® 96

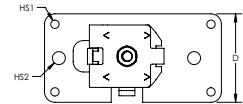

Conductor Size, UL: Class 1 - Class 2 (4/0 Max)



Part Number	Contact Area	Depth	Height	Width	Hole Size 1	Hole Size 2	Unit Weight
Material: Aluminum – Finish: Bare							
LPA540	51.6 cm ² Min	53.98 mm	31.75 mm	107.95 mm	5.1 mm	7.9 mm	0.088 kg
Material: Copper – Finish: Tinned							
LPC540L	51.6 cm ² Min	53.98 mm	31.75 mm	107.95 mm	5.1 mm	7.9 mm	0.254 kg
Material: Copper, Aluminum, Stainless Steel 304 (EN 1.4301) – Finish: Bare							
LPC540A	51.6 cm ² Min	53.98 mm	31.75 mm	107.95 mm	5.1 mm	7.9 mm	0.104 kg

Stainless steel separator included with LPC540A for bi-metallic applications.

BONDING PLATE

FEATURE

- Cast bonding plate for structural steel applications
- Listed to UL® 96

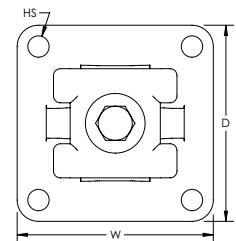

Conductor Size, UL: Class 1 - Class 2 (4/0 Max)
Material: Brass



Part Number	Contact Area	Depth	Height	Width	Hole Size	Unit Weight
LPC532	51.6 cm ² Min	73.03 mm	16.76 mm	73.025 mm	79.38 mm	0.29 kg

CAST BEAM BONDING CLAMP

FEATURE

- Clamp for bonding cable to flat metal objects such as I-beams, angle irons and channel irons
- Listed to UL® 96



Conductor Size, UL: Class 1 - Class 2 (4/0 Max)



Part Number	Flange Thickness	Depth	Width	Unit Weight
Material: Aluminum — Finish: Bare				
LPA559	6.4 mm Max	57.15 mm	40.6 mm	0.061 kg
Material: Copper — Finish: Bare				
LPC559	6.4 mm Max	57.15 mm	40.6 mm	0.175 kg
Material: Copper — Finish: Tinned				
LPC559L	6.4 mm Max	57.15 mm	40.6 mm	0.175 kg

CAST TWO BOLT BEAM BONDING CLAMP

FEATURE

- Clamp for bonding cable to flat metal objects such as I-beams, angle irons and channel irons
- Listed to UL® 96

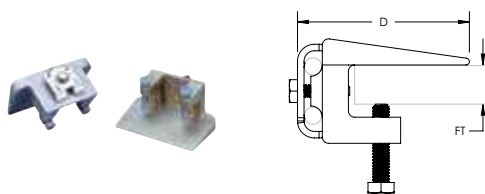

Conductor Size, UL: Class 1 - Class 2 (4/0 Max)



Part Number	Flange Thickness	Depth	Height	Width	Contact Area	Unit Weight
Material: Aluminum						
LPA557	25.4 mm Max	69.85 mm	50.8 mm	101.6 mm	51.613 mm ² Min	0.315 kg
Material: Copper						
LPC557	25.4 mm Max	69.85 mm	50.8 mm	101.6 mm	51.613 mm ² Min	0.932 kg
Material: Copper — Finish: Tinned						
LPC557L	25.4 mm Max	69.85 mm	50.8 mm	101.6 mm	51.613 mm ² Min	0.932 kg

BEAM CLAMP FOR SOLID ROUND CONDUCTOR

FEATURE

- Clamp for attaching solid round conductor such as nVent ERICO Cu-Bond Round Conductor to flat metal objects such as I-beams, angle irons and channel irons
- For use with copper-bonded, copper, or stainless steel solid conductors

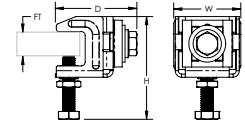

Material: Stainless Steel 316 (EN 1.4401)

Part Number	Width	Height	Depth	Flange Thickness	nVent ERICO Cu-Bond Conductor	Unit Weight	Complies With
SBCS0810	55 mm	85 mm	70 mm	6 – 25 mm	CBSC8, CBSC10	0.277 kg	IEC® 62561-4
SBCS1314	55 mm	90 mm	70 mm	6 – 25 mm	CBSC13, CBSC14	0.277 kg	IEC® 62561-4

IEC compliance is valid only for nVent ERICO Cu-Bond Conductors listed.

LAY-IN LUG

FEATURE

- Often used in solar bonding lug applications
- Lay-in features allows for easy positioning
- Set screw hardware made of 304 stainless steel

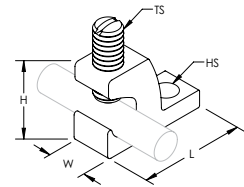

Material: Copper, Stainless Steel 304 (EN 1.4301)
Finish: Tinned



Part Number	Length	Width	Height	Hole Size	Thread Size	Conductor Size
EL6CADB	26.4 mm	9.9 mm	19.3 mm	5.58 mm	1/4 NF	#14 Solid - #4 Stranded, 2.5 mm ² Stranded - 16 mm ² Stranded

SOLAR BONDING LUG

FEATURE

- Bonds the frames and mounting structures of solar photo voltaic systems in accordance with NEC® requirements
- Copper alloy is corrosion resistant and galvanically compatible with copper grounding conductors and aluminum photovoltaic module frames
- Lay-in feature allows for easy positioning along multiple frames

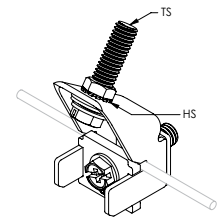

Material: Bronze, Stainless Steel 18-8 (EN 1.4305)
Finish: Tinned



Part Number	Direct Burial	Conductor Size	Hole Size	Screw Included
EL6CSNH	No	#14 Solid - #6 Stranded	5.61 mm	No

EARTH BOSS

FEATURE

- Provides preferential equipotential bonding connection point
- Stainless steel hardware included

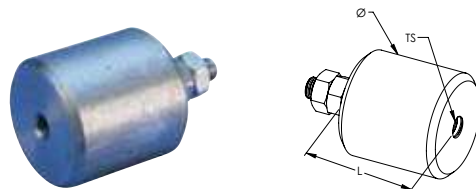

Material: Steel

Part Number	Article Number	Length	Diameter	Thread Size
50010EBOSS	710160	50 mm	50 mm	M10

Apply dry-to-touch oil on earth boss to prevent rust. Welding procedures vary, depending on the type of steel used.

516 PARALLEL CABLE CONNECTOR

FEATURE

- Cable splice with positive single bolt tension grip on cable or wire
- For use with all full size cables on Class I/ II structures
- Listed to UL® 96

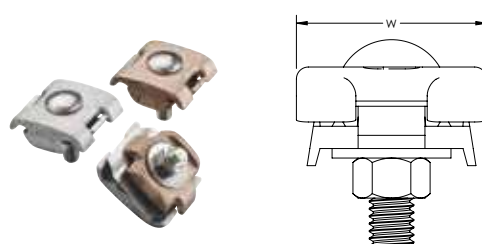

Conductor Size, UL: Class 1 - Class 2 (4/0 Max)



Part Number	Depth	Width	Unit Weight
Material: Aluminum – Finish: Bare			
LPA516	46.74 mm	38.1 mm	0.064 kg
Material: Copper – Finish: Bare			
LPC516	46.74 mm	38.1 mm	0.181 kg
Material: Copper – Finish: Tinned			
LPC516L	46.74 mm	38.1 mm	0.181 kg
Material: Copper, Aluminum, Stainless Steel 18-8 (EN 1.4305) – Finish: Bare			
LPC516A	46.74 mm	38.1 mm	0.120 kg

517 PARALLEL CABLE CONNECTOR

FEATURE

- Cable splice with positive two bolt tension grip on cable or wire
- For use with all full size cables on Class I/ II structures
- Listed to UL® 96

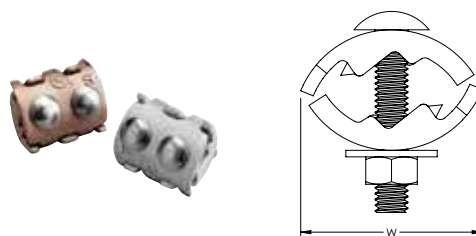

Conductor Size, UL: Class 1 - Class 2 (4/0 Max)

Material: Copper



Part Number	Depth	Width	Unit Weight
LPC517	48.51 mm	42.16 mm	0.233 kg

STAMPED BOLTED PARALLEL CABLE CONNECTOR

FEATURE

- For positive bolt tension cable clamping
- Listed to UL® 96

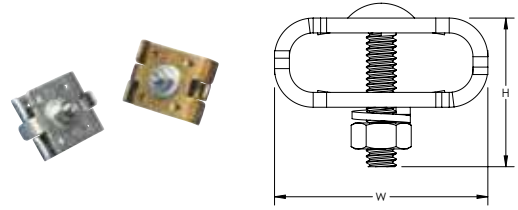

Conductor Size, UL: Class 1 - Class 2 (4/0 Max)



Part Number	Depth	Height	Width	Unit Weight
Material: Aluminum				
LPA502	38.1 mm	38.1 mm	45.2 mm	0.039 kg
Material: Copper				
LPC502	38.1 mm	38.1 mm	45.2 mm	0.087 kg
Material: Copper – Finish: Tinned				
LPC502L	38.1 mm	38.1 mm	45.2 mm	0.087 kg
Material: Copper, Aluminum, Stainless Steel 304 (EN 1.4301)				
LPC502A	38.1 mm	38.1 mm	45.2 mm	0.088 kg

Stainless steel separator included with LPC502A for bi-metallic applications.

CROSS-RUN CABLE CONNECTORS, SOLID ROUND CONDUCTOR

FEATURE

- Can be used as a cross-run cable connector
- Four bolts for positive bolt tension grip on cables
- For use with nVent ERICO Cu-Bond Round Conductors

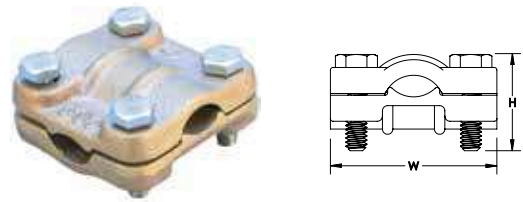

Material: Brass

Part Number	Depth	Height	Width	nVent ERICO Cu-Bond Conductor	Unit Weight	Complies With
LPC595NB	50.8 mm	25.40 mm	50.8 mm	CBSC8, CBSC10	0.281 kg	IEC® 62561-1
LPC595NB13	50.8 mm	31.75 mm	50.8 mm	CBSC13	0.281 kg	IEC® 62561-1

IEC compliance is valid only for nVent ERICO Cu-Bond Conductors listed.

T-CONNECTOR

FEATURE

- For 90° conductor connections

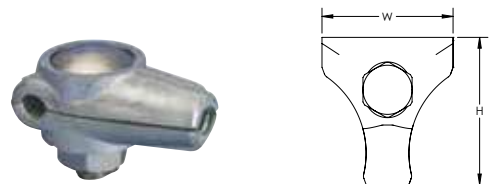

Material: Brass

Part Number	Conductor Size	Depth	Height	Width	nVent ERICO Cu-Bond Conductor	Unit Weight	Complies With
CTR8CU	8 mm Solid, 10 mm Solid	21 mm	46 mm	40 mm	CBSC10	0.168 kg	IEC® 62561-1

IEC compliance is valid only for nVent ERICO Cu-Bond Conductors listed.

IN-LINE CABLE CONNECTOR

FEATURE

- Cable splicer with four bolts for pressure on each cable
- LPC513 is compatible with nVent ERICO Cu-Bond Round Conductors

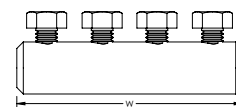

Conductor Size, UL: Class 1 - Class 2 (4/0 Max)



Part Number	Diameter 1	Diameter 2	Width	nVent ERICO Cu-Bond Conductor	Unit Weight	Complies With
Material: Aluminum						
LPA513	19.1 mm	14.3 mm	82.55 mm		0.086 kg	
Material: Copper						
LPC513	19.1 mm	14.3 mm	82.55 mm	CBSC8, CBSC10, CBSC13	0.168 kg	IEC® 62561-1

IEC compliance is valid only for nVent ERICO Cu-Bond Conductors listed.

MESH BONDING NETWORK CONNECTOR, MBNC240

FEATURE

- Allows for fast, simple and economical field connection of grounding and bonding wires
- Heavy duty clamps with stainless steel hardware are suitable for direct burial
- Can accommodate additional pigtails that can be used to connect to building steel and equipment
- Can be combined with Universal Pedestal Clamp for bonding to various pedestal sizes for mesh bonding networks

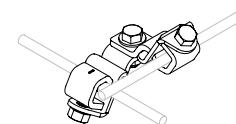

Material: Copper, Stainless Steel 304 (EN 1.4301)



Part Number	Conductor Size	nVent ERICO Cu-Bond Conductor	Complies With	Standard Packaging Quantity
MBNC240	#2 Solid - 4/0 Stranded, 35 mm ² - 100 mm ²	CBSC8, CBSC10, CBSC13	IEC® 62561-1	25 pc

IEC compliance is valid only for nVent ERICO Cu-Bond Conductors listed.

MESH BONDING NETWORK CONNECTOR, MBNC240A

FEATURE

- Allows for fast, simple and economical field connection of grounding and bonding wires
- Heavy duty clamps with stainless steel hardware are suitable for direct burial
- Can be combined with Universal Pedestal Clamp for bonding to various pedestal sizes for mesh bonding networks

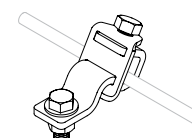

Material: Copper, Stainless Steel 304 (EN 1.4301)



Part Number	Conductor Size	Standard Packaging Quantity
MBNC240A	#2 Solid - 4/0 Stranded, 35 mm ² - 100 mm ²	25 pc

MESH BONDING NETWORK CONNECTOR, MBNC82

FEATURE

- Allows for fast, simple and economical field connection of grounding and bonding wires
- Heavy duty clamps with stainless steel hardware are suitable for direct burial
- Can accommodate additional pigtails that can be used to connect to building steel and equipment
- Can be combined with Universal Pedestal Clamp for bonding to various pedestal sizes for mesh bonding networks

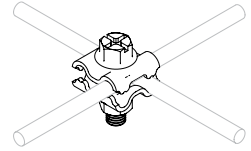

Material: Bronze, Stainless Steel 304 (EN 1.4301)



Part Number	Conductor Size	Standard Packaging Quantity
MBNC82	#8 Solid - #2 Stranded, 10 mm ² Solid - 35 mm ² Stranded	25 pc

SRG CONNECTOR

FEATURE

- Allows for fast, simple and economical field connection of grounding and bonding wires
- Heavy duty clamps with stainless steel hardware are suitable for direct burial
- Can accommodate additional pigtails that can be used to connect to building steel and equipment
- Can be combined with Universal Pedestal Clamp for bonding to various pedestal sizes for mesh bonding networks

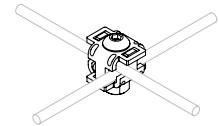

Material: Bronze, Stainless Steel 304 (EN 1.4301)



Part Number	Article Number	Conductor Size
SRGC46	167905	#6 Solid - #4 Stranded, 16 mm ² Stranded

SPLIT BOLT CONNECTOR

FEATURE

- Unplated high-strength silicon bronze accommodates copper to copper connections
- Tin plated, high-strength copper alloy split bolt with spacer separates dissimilar conductors and accommodates copper-to-copper, copper-to-aluminum and aluminum-to-aluminum connections

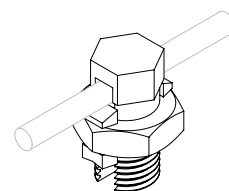

Material: Silicon Bronze



Part Number	Conductor Size	Torque	Certifications
Tin Plating: No			
ESB8	#16 Stranded - #8 Stranded, 1.5 mm ² Stranded - 6 mm ² Stranded	18.6 N-m	cULus
ESB6	#10 Solid - #6 Stranded, 6 mm ² Stranded - 10 mm ² Stranded	18.6 N-m	cULus
ESB4	#8 Solid - #4 Solid, 10 mm ² Stranded - 16 mm ² Stranded	18.6 N-m	cULus
ESB2	#6 Solid - #2 Stranded, 16 mm ² Stranded - 25 mm ² Stranded	31.1 N-m	cULus
ESB2/0	#2 Solid - 2/0 Stranded, 35 mm ² Stranded - 50 mm ² Stranded	43.5 N-m	UL
ESB4/0	1/0 Solid - 250 kcmil Stranded, 70 mm ² Stranded - 120 mm ² Stranded	73.4 N-m	
Tin Plating: Yes			
ESBP8	#14 Stranded - #8 Stranded, 2.5 mm ² Stranded - 6 mm ² Stranded	18.6 N-m	UL
ESBP6	#10 Stranded - #6 Stranded, 6 mm ² Stranded - 10 mm ² Stranded	18.6 N-m	UL
ESBP4	#8 Solid - #3 Stranded, 10 mm ² Stranded - 25 mm ² Stranded	18.6 N-m	UL
ESBP2	#8 Solid - #2 Stranded, 10 mm ² Stranded - 25 mm ² Stranded	31.1 N-m	UL
ESBP2/0	#8 Solid - 2/0 Stranded, 10 mm ² Stranded - 50 mm ² Stranded	43.5 N-m	UL
ESBP1/0	#6 Solid - 1/0 Stranded, 16 mm ² Stranded - 50 mm ² Stranded	43.5 N-m	UL
ESBP4/0	#4 Stranded - 250 kcmil Stranded, 25 mm ² Stranded - 120 mm ² Stranded	73.4 N-m	
ESBP350	3/0 Stranded - 350 kcmil Stranded, 95 mm ² Stranded - 150 mm ² Stranded	73.4 N-m	

Oxide inhibitor recommended when used on aluminum conductor.

MULTI-PURPOSE GROUNDING CLAMP

FEATURE

- Cross connector for round-to-round, round-to-tape, and tape-to-tape connections

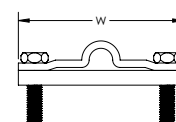

Part Number	Article Number	Conductor Size	Tape Size	Depth	Width	Unit Weight
Material: Brass						
CCFR308	545270	8 mm Stranded, 8 mm Solid	25 x 3 mm, 30 x 2 mm	56 mm	56 mm	0.15 kg
Material: Stainless Steel 304 (EN 1.4301)						
CCS-308	545180	8 mm Stranded, 8 mm Solid	25 x 3 mm, 30 x 2 mm	56 mm	56 mm	0.15 kg
Material: Steel – Finish: Hot-Dip Galvanized						
CCG308	545170	8 mm Stranded, 8 mm Solid	25 x 3 mm, 30 x 2 mm	56 mm	56 mm	0.15 kg

MULTI-PURPOSE GROUNDING CLAMP, STAINLESS STEEL

FEATURE

- Convenient multi-purpose clamp designed to accommodate round conductors, flat conductors, ground rods and rebar
- Stainless steel material with inner plate allows compatibility between most dissimilar metals

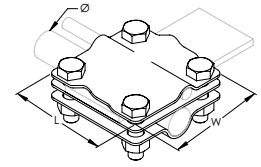
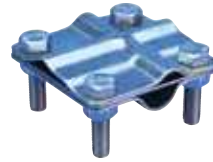

Material: Stainless Steel 304 (EN 1.4301)

Conductor Size: 35 mm² Stranded - 50 mm² Stranded, #2 Stranded - 1/0 Solid

Tape Size: 40 x 4 mm Max

Part Number	Article Number	Ground Rod Diameter, Nominal	Ground Rod Diameter, Actual	Rebar Size, Metric	Rebar Size, US	Rebar Size, Canada	Length	Width
MPSC404SS	120319	5/8" - 3/4"	14.2 - 19.0 mm	16 - 20 mm	#5 - #6	15M - 20M	65 mm	65 mm

UNIVERSAL CLAMP, SOLID ROUND CONDUCTOR

FEATURE

- For parallel connections of nVent ERICO Cu-Bond Round Conductor

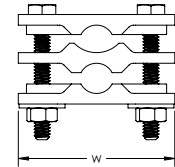

Material: Brass

Part Number	Depth	Width	nVent ERICO Cu-Bond Conductor	Unit Weight	Complies With
LPC466B	31.7 mm	63.5 mm	CBSC10, CBSC13	0.279 kg	IEC® 62561-1

IEC compliance is valid only for nVent ERICO Cu-Bond Conductors listed.

WATER PIPE GROUND CLAMP

FEATURE

- High-strength silicone bronze
- Used for connecting copper conductors to metallic water pipe or ground rods

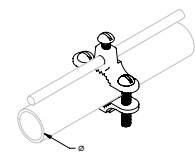

Part Number	Article Number	Pipe Size, Nominal	Pipe Size, Actual	Conductor Size	Certifications
Material: Silicon Bronze					
CWP1JJ	710262	1/2" - 1"	12.7 - 25.4 mm	#10 Solid - #4 Stranded, 6 mm ² Stranded - 16 mm ² Stranded	
CWP1JU	710266	1/2" - 1"	12.7 - 25.4 mm	#10 Solid - #2 Stranded, 6 mm ² Stranded - 25 mm ² Stranded	CSA, cULus
CWP2JU	710267	1 1/4" - 2"	31.8 - 50.8 mm	#10 Solid - #2 Stranded, 6 mm ² Stranded - 25 mm ² Stranded	CSA, cULus
CWP4J	710264	2 1/2" - 4"	63.5 - 101.6 mm	#10 Solid - #4 Stranded, 6 mm ² Stranded - 16 mm ² Stranded	CSA, cULus
CWP6J	710265	4 1/2" - 6"	108.0 - 152.4 mm	#10 Solid - #4 Stranded, 6 mm ² Stranded - 16 mm ² Stranded	CSA
Material: Zinc Alloy					
ZWP1J	710268	1/2" - 1"	12.7 - 25.4 mm	#10 Solid - #6 Solid, 6 mm ² Stranded - 10 mm ² Stranded	cULus

WATER/GAS PIPE GROUND CLAMP

FEATURE

- High-strength silicone bronze
- Used for connecting copper conductors to metallic water pipe, ground rods, or flexible gas pipe (CSST) with brass hex fittings
- Conform to the requirements of the 2009 edition of NFPA® 54, NFGC® (National Fuel Gas Code) and NEC® (National Electric Code) for bonding corrugated stainless steel tubing (CSST) gas piping systems to the grounding conductor of the building's electrical system
- SH version for outdoor applications

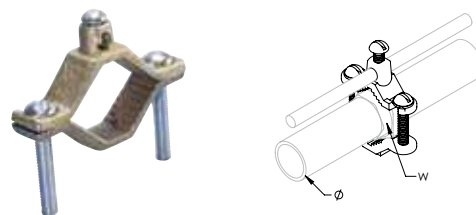

Material: Silicon Bronze
For Outdoor Use: No



Part Number	Article Number	Pipe Size, Nominal	Pipe Size, Actual	Hex Width	Conductor Size
CWP1J	710261	1/2" - 1"	12.7 - 25.4 mm	25.4 - 31.8 mm	#10 Solid - #2 Solid, 6 mm ² Solid - 25 mm ² Stranded
CWP2J	710263	1 1/4" - 2"	31.8 - 50.8 mm	38.1 - 54.0 mm	#10 Solid - #2 Stranded, 6 mm ² Stranded - 25 mm ² Stranded

CAST PIPE CLAMP

FEATURE

- Clamp for bonding horizontal or vertical pipes to the lightning protection system
- Listed to UL® 96

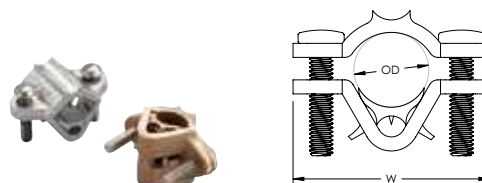

Conductor Size, UL: Class 1 - Class 2 (4/0 Max), Secondary
Material: Brass
Finish: Tinned



Part Number	Outer Diameter	Depth	Width	Unit Weight
LPC580L	19.1 - 33.5 mm	38.1 mm	69.85 mm	0.268 kg

CAST U-BOLT PIPE CLAMP

FEATURE

- Clamp for bonding conductor to handrails, pipes and rebar to lightning protection system
- Listed to UL® 96

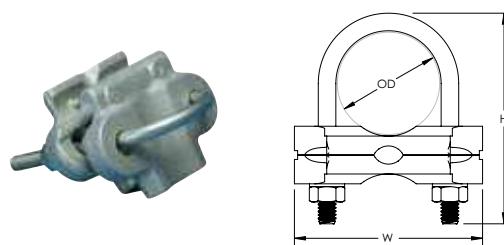

Conductor Size, UL: Class 1 - Class 2 (4/0 Max), Secondary
Material: Brass



Part Number	Outer Diameter	Depth	Height	Width	Unit Weight
Finish: Bare					
LPC570	17.3 - 38.1 mm	45.72 mm	76.2 mm	67.818 mm	0.324 kg
Finish: Tinned					
LPC570L	17.3 - 38.1 mm	45.72 mm	76.2 mm	67.818 mm	0.324 kg

NOTCHED CAST U-BOLT PIPE CLAMP

FEATURE

- Clamp for bonding of handrails and pipes to the lightning protection system
- Notched hole makes assembly easy and eliminates loose hardware
- Listed to UL® 96

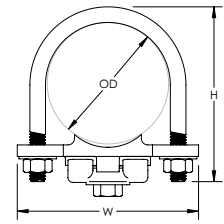

Conductor Size, UL: Class 1 - Class 2 (4/0 Max)
Material: Brass
Finish: Bare



Part Number	Outer Diameter	Depth	Height	Width	Unit Weight
LPC571	50.8 – 63.5 mm	49.78 mm	88.9 mm	92.2 mm	0.379 kg

STAMPED U-BOLT PIPE CLAMP

FEATURE

- Clamp for bonding of pipes and exhaust stacks to the lightning protection system
- Listed to UL® 96

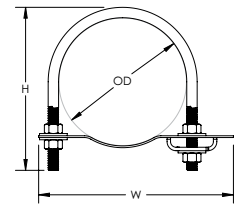

Material: Copper, Stainless Steel 304 (EN 1.4301)



Part Number	Outer Diameter	Depth	Height	Width	Unit Weight
LPC5964	99.1 – 108.0 mm	50.8 mm	147.64 mm	158.75 mm	0.401 kg
LPC5966	111.1 – 174.2 mm	50.8 mm	223.84 mm	211.15 mm	0.372 kg

STAMPED U-BOLT PIPE CLAMP, 90°

FEATURE

- Clamp for bonding of pipes, handrails and exhaust stacks to the lightning protection system
- Listed to UL® 96

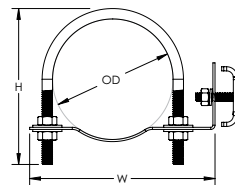

Conductor Size, UL: Class 1 - Class 2 (4/0 Max)
Material: Copper, Stainless Steel 304 (EN 1.4301)



Part Number	Outer Diameter	Depth	Height	Width	Unit Weight
LPC5962	48.3 – 66.7 mm	50.8 mm	92.00 mm	118.745 mm	0.234 kg
LPC5963	66.8 – 92.2 mm	50.8 mm	119.19 mm	139.700 mm	0.346 kg

CABLE/POINT PIPE SUPPORT

FEATURE

- Clamp for bonding horizontal or vertical pipes to the lightning protection system
- May be used as a vertical support for air terminals
- Listed to UL® 96

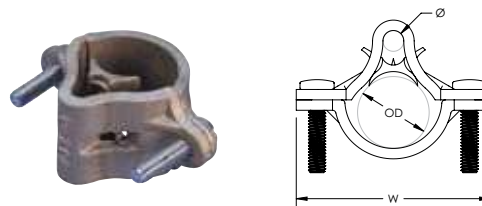

Material: Brass
Finish: Tinned



Part Number	Diameter	Outer Diameter	Depth	Width	Unit Weight
LPC331L	9.5 mm	44.5 – 63.5 mm	41.28 mm	99 mm	0.379 kg

FENCE CLAMP, ONE CONDUCTOR

FEATURE

- Theft-deterrent appearance
- Stainless steel hardware included
- Tin plating minimizes the risk of corrosion
- The clamp accepts the conductor either in parallel or at right angles to the pipe

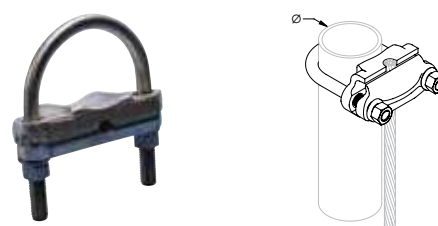

Material: Bronze, Stainless Steel 304 (EN 1.4301)
Finish: Tinned



Part Number	Article Number	Fence Post Size, Nominal	Fence Post Outside Diameter, Actual	Conductor Size	nVent ERICO Cu-Bond Conductor	Complies With	Certifications
FC073	198401	1 1/2"	48 mm	#4 Solid - 2/0 Stranded, 16 mm ² Stranded - 70 mm ² Stranded			
FC074	198402	1 1/2"	48 mm	2/0 Solid - 250 kcmil Stranded, 50 mm ² Stranded - 120 mm ² Stranded			
FC075	198403	2"	60 mm	#4 Solid - 2/0 Stranded, 16 mm ² Stranded - 70 mm ² Stranded	CBSC8	IEC® 62561-1	cULus
FC076	198404	2"	60 mm	2/0 Solid - 250 kcmil Stranded, 50 mm ² Stranded - 120 mm ² Stranded	CBSC10, CBSC13	IEC® 62561-1	
FC078	198406	2 1/2"	73 mm	2/0 Solid - 250 kcmil Stranded, 16 mm ² Stranded - 120 mm ² Stranded			
FC079	198407	3"	89 mm	#4 Solid - 2/0 Stranded, 16 mm ² Stranded - 70 mm ² Stranded			
FC080	198408	3"	89 mm	2/0 Solid - 250 kcmil Stranded, 50 mm ² Stranded - 120 mm ² Stranded			
FC082	198411	3 1/2"	102 mm	#4 Solid - 2/0 Stranded, 16 mm ² Stranded - 120 mm ² Stranded			

IEC compliance is valid only for nVent ERICO Cu-Bond Conductors listed.

FENCE CLAMP, TWO CONDUCTORS

FEATURE

- Theft-deterrent appearance
- Stainless steel hardware included
- Tin plating minimizes the risk of corrosion

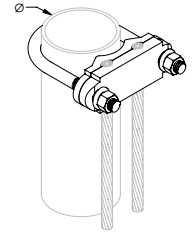

Material: Copper Alloy, Stainless Steel 304 (EN 1.4301)
Finish: Tinned



Part Number	Fence Post Size, Nominal	Fence Post Outside Diameter, Actual	Conductor Size
FC082DH	3 1/2"	101.6 mm	#4 Solid - 2/0 Stranded, 16 mm ² Stranded - 120 mm ² Stranded

REBAR GROUNDING CLAMP, PARALLEL

FEATURE

- Universal use for rebar, rods or pipes
- Lay-in feature cuts installation time
- Bronze alloy construction with Stainless Steel 304 screws
- Approved for direct burial in earth and concrete

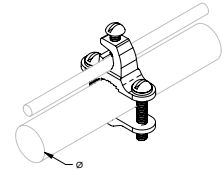

Material: Bronze, Stainless Steel 304 (EN 1.4301)
Connection Type: Parallel
Conductor Size:



Part Number	Article Number	Ground Rod Diameter, Actual	Water Pipe Size	Rebar Size, Metric	Rebar Size, US	Rebar Size, Canada
EK16	710355	12.7 – 25.4 mm	12.7 – 25.4 mm	12 – 25 mm	#4 – #8	10M – 25M

REBAR GROUNDING CLAMP, PERPENDICULAR

FEATURE

- Universal use for rebar, rods or pipes
- Lay-in feature cuts installation time
- Bronze alloy construction with Stainless Steel 304 screws
- Approved for direct burial in earth and concrete

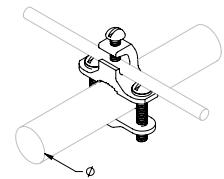

Material: Bronze, Stainless Steel 304 (EN 1.4301)
Connection Type: Perpendicular
Conductor Size:



Part Number	Article Number	Ground Rod Diameter, Actual	Water Pipe Size	Rebar Size, Metric	Rebar Size, US	Rebar Size, Canada
EK17	710365	12.7 – 25.4 mm	12.7 – 25.4 mm	12 – 25 mm	#4 – #8	10M – 25M

REBAR GROUNDING CLAMP, HEAVY DUTY

FEATURE

- Provides two connection points to concrete encased electrodes (rebar) for states where the Authority Having Jurisdiction (AHJ) requires it
- Meets 2005 NEC® standard requirement for bonding to rebar into the grounding system
- Suitable for direct burial applications
- Has high-strength bronze alloy construction
- Easy to install



Material: Bronze



Part Number	Article Number	Rebar Size, Metric	Rebar Size, US	Rebar Size, Canada
Conductor Size: #8 Solid - 2/0 Stranded, 10 mm² Stranded - 70 mm² Stranded				
RC70	710325	8 – 18 mm	#3 – #6	10M – 20M
Conductor Size: #8 Solid - 4/0 Stranded, 10 mm² Stranded - 100 mm² Stranded				
RC100	710335	18 – 36 mm	#6 – #11	20M – 35M

REBAR BONDING CLAMP

FEATURE

- Provides bond from lightning protection system to rebar

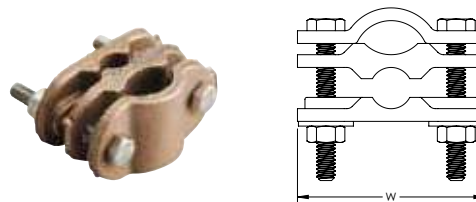

Material: Brass

Conductor Size, UL: Class 2 (4/0 Max)



Part Number	Rebar Size, Canada	Rebar Size, Metric	Rebar Size, US	Depth	Width	Unit Weight
LPC466	10M Max	29 mm Max	#9 Max	31.7 mm	63.5 mm	0.279 kg

ARC WELDABLE BOND

FEATURE

- 19-strand concentric cable flash-welded to steel rod for a bonding connection to structural steel and to rebar
- Economical alternative to exothermic welding when only a few connections need to be made and an arc welder is available on site
- Rod is sized to match the ampacity of the cable for fault currents



Material: Copper, Steel

Part Number	Conductor Size	Cable Length	Rod Size	Rod Length
EWB2G9164	2/0 Stranded	1.2 m	14 mm	203 mm
EWB2L584	3/0 Stranded	1.2 m	16 mm	203 mm
EWB2Q344	4/0 Stranded	1.2 m	19 mm	203 mm

UNIVERSAL PEDESTAL CLAMP WITH CABLE MANAGEMENT, MBNUPCJ240

FEATURE

- Only one attachment required for both mesh bonding and cable management
- Eliminates the need for separate mounting brackets for different pedestal types or sizes
- Stainless steel construction of bracket and hardware reduces potential for galvanic corrosion
- Mesh bonding conductors do not have to bend around each pedestal to conform to grid pattern
- Suitable for round or square pedestals

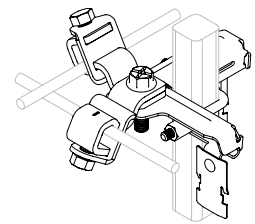

Material: Copper, Steel, Stainless Steel 304 (EN 1.4301)
Finish: nVent CADDY Armour, ElectroGalvanized



Part Number	Conductor Size	Pedestal Size	Standard Packaging Quantity
MBNUPCJ240	#2 Solid - 4/0 Stranded, 35 mm ² - 100 mm ²	22 - 51 mm Round or Square	25 pc

UNIVERSAL PEDESTAL CLAMP WITH CABLE MANAGEMENT, MBNUPCJ82

FEATURE

- Only one attachment required for both mesh bonding and cable management
- Eliminates the need for separate mounting brackets for different pedestal types or sizes
- Stainless steel construction of bracket and hardware reduces potential for galvanic corrosion
- Mesh bonding conductors do not have to bend around each pedestal to conform to grid pattern
- Suitable for round or square pedestals

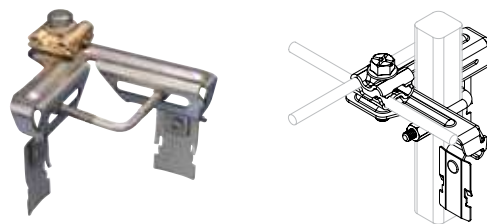

Material: Bronze, Steel, Stainless Steel 304 (EN 1.4301)
Finish: nVent CADDY Armour, Electrogalvanized



Part Number	Conductor Size	Pedestal Size	Standard Packaging Quantity
MBNUPCJ82	#8 Solid - #2 Stranded, 10 mm ² Solid - 35 mm ² Stranded	22 - 51 mm Round or Square	25 pc

SRG CONNECTOR PEDESTAL MOUNTING BRACKET

FEATURE

- Mounts SRGC46 connector to square or round pedestals
- Simplifies retrofit installations

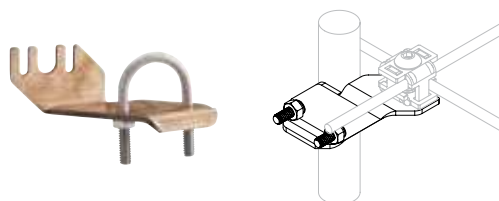

Material: Stainless Steel 304 (EN 1.4301), Bronze



Part Number	Article Number	Pedestal Size	Standard Packaging Quantity
SRGC46BR	167906	22 mm Square; 25 mm Round	10 pc

COPPER LUG MECHANICAL CONNECTOR

FEATURE

- Simple to use and install
- Suitable for telecom and equipotential bonding applications

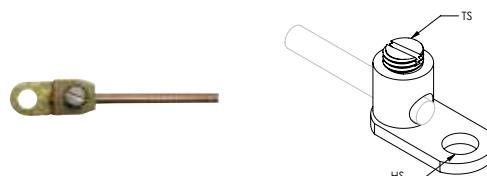

Material: Copper



Part Number	Conductor Size	Thread Size	Hole Size
EL4	#14 Solid - #4 Stranded, 2.5 mm ² Stranded - 16 mm ² Stranded	5/16 UNF	7.2 mm

FLUSH MOUNT POSITIONER, SOLID ROUND CONDUCTOR

FEATURE

- Flush-mount positioning clamps for use with solid round conductors, including nVent ERICO Cu-Bond Round Conductor
- For use with copper-bonded, copper, or stainless steel solid conductors

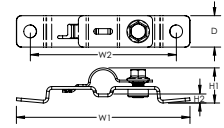

Material: Stainless Steel 18-8 (EN 1.4305), Stainless Steel 316 (EN 1.4401)

Part Number	Width 1	Width 2	Height 1	Height 2	Depth	nVent ERICO Cu-Bond Conductor	Unit Weight	Complies With
CSS0810000	95 mm	80 mm	20 mm	5 mm	17 mm	CBSC8, CBSC10	0.009 kg	IEC® 62561-4

IEC compliance is valid only for nVent ERICO Cu-Bond Conductors listed.

Conductors

NVENT ERICO CU-BOND COMPOSITE CABLE

FEATURE

- Outer strands comprised of tinned copper-bonded steel for theft deterrence and improved corrosion resistance
- Inner copper stranding is tinned for superior corrosion resistance
- Copper stranding inside of conductor increases conductivity and conductor flexibility
- Available in three sizes/configurations with electrical equivalency to 4, 2/0 and 4/0 AWG copper
- Suitable for direct burial applications
- More flexible and easier to work with than copper clad steel conductors



nVent ERICO Cu-Bond is a bare concentric stranded conductor that consists of peripheral tinned copper plated steel which protects and conceals the internal copper stranding. This conductor is ideal for exposed electrical grounding applications where copper theft may occur due to its tinned outer strands. The conductor is difficult to cut with hand tools, but the copper core makes it easier to install than other theft deterrent conductors. The outer stranding is magnetic, which further deters thieves looking for copper. The CC5A05CB (19 strand) is electrically equivalent to a 4 AWG (25 mm²), the CC5A20CB is electrically equivalent to a 2/0 AWG (70 mm²) and the CC5A40CB is electrically equivalent to a 4/0 AWG (120 mm²). These conductors are ideal for transmission tower, distribution pole and a wide range of above and below grade grounding applications.

Material: Copper, Copper-Bonded Steel
 Finish: Tinned
 Insulated: No

Part Number	Stranding	Resistance	Fusing Capacity Equivalency	Cable Diameter	Cable Length	Conductor Code	nVent ERICO Hammerlock	Unit Weight
CC5A05CB	(19) Strands: (3) Tinned Copper, (16) Tin Plated Copper-Bonded Steel	1,227.000 Ω/km	25 mm ²	8.1 mm	76.2 m	S1	EHL58C2G, EHL34C2G	28 kg
CC5A20CB	(154) Strands: (133) Tinned Copper, (21) Tin Plated Copper-Bonded Steel	0.285 Ω/km	70 mm ²	13.3 mm	61.0 m	S5		51 kg
CC5A40CB	(161) Strands: (133) Tinned Copper, (27) Tinned Copper-Bonded Steel	0.182 Ω/km	120 mm ²	16.5 mm	61.0 m	S7		79 kg

Weight does not include reel.

Please contact your nVent ERICO Customer Service Representative for other nVent ERICO Cadweld configurations.

nVent ERICO CADWELD Connections for nVent ERICO CU-BOND Composite Cable						
Part Number	nVent ERICO CU-BOND Composite Cable	nVent ERICO CADWELD Welding Material	nVent ERICO CADWELD PLUS Welding Material	nVent ERICO CADWELD Connection Type	Connects To	Handle Clamp
SSCS1	CC5A05CB	32	32PLUSF20	SS	T1 Cable	L160
SSCS5	CC5A20CB	90	90PLUSF20	SS	T2 Cable	L160
SSCS7	CC5A40CB	150	150PLUSF20	SS	T3 Cable	L160
GRC16S1	CC5A05CB	65	65PLUSF20	GR	5/8" Copper- Bonded Ground Rod	L160
GRC16S5	CC5A20CB	90	90PLUSF20	GR	5/8" Copper- Bonded Ground Rod	L160
GRC16S7	CC5A40CB	115	115PLUSF20	GR	5/8" Copper- Bonded Ground Rod	L160
GRC18S1	CC5A05CB	90	90PLUSF20	GR	3/4" Copper- Bonded Ground Rod	L160
GRC18S5	CC5A20CB	90	90PLUSF20	GR	3/4" Copper- Bonded Ground Rod	L160
GRC18S7	CC5A40CB	115	115PLUSF20	GR	3/4" Copper- Bonded Ground Rod	L160
GLCCES1	CC5A05CB	32	32PLUSF20	GL	B121CE or B122CE Lug	L160
GLCCES5	CC5A20CB	45	45PLUSF20	GL	B121CE or B122CE Lug	L160
GLCCES7	CC5A40CB	65	65PLUSF20	GL	B121DE or B122DE Lug	L160
GTC16S1	CC5A05CB	90	90PLUSF20	GT	5/8" Copper- Bonded Ground Rod	L160
GTC16S5	CC5A20CB	115	115PLUSF20	GT	5/8" Copper- Bonded Ground Rod	L160
GTC16S7	CC5A40CB	200	200PLUSF20	GT	5/8" Copper- Bonded Ground Rod	L160
GTC18S1	CC5A05CB	90	90PLUSF20	GT	3/4" Copper- Bonded Ground Rod	L160
GTC18S5	CC5A20CB	115	115PLUSF20	GT	3/4" Copper- Bonded Ground Rod	L160
GTC18S7	CC5A40CB	200	200PLUSF20	GT	3/4" Copper- Bonded Ground Rod	L160
LACS1CE	CC5A05CB	45	45PLUSF20	LA	B101CEOL or B102CEOL Lug	L160
LACS5CE	CC5A20CB	65	65PLUSF20	LA	B101CEOL or B102CEOL Lug	L160
LACS7DE	CC5A40CB	90	90PLUSF20	LA	B101DEOL or B102DEOL Lug	L160

Conductor Sizes			
Cable	Diameter (Inches)	Diameter (mm)	Cross Sectional Area (mm ²)
35 mm ²	0.305	7.8	35
CCA05CB	0.32	8.1	33.2 (Steel) / 6.8 (Copper)
1 AWG	0.332	8.4	42.4
50 mm ²	0.365	9.3	50
95 mm ²	0.505	12.8	95
CC5A20CB	0.524	13.3	43.6 (Steel) / 49.9 (Copper)
4/0 AWG	0.528	13.4	107.2
120 mm ²	0.567	14.4	120
300 kcmil	0.63	16	152.1
150 mm ²	0.63	16	150
CC5A40CB	0.651	10.5	56.0 (Steel) / 86.9 (Copper)
350 kcmil	0.681	17.3	177.3
185 mm ²	0.7	17.8	185

CU-BOND ROUND CONDUCTOR



Substation earthing riser

For decades, nVent ERICO has provided the market with high quality copper-bonded ground rods.

nVent ERICO has taken that same concept in ground rods and made this into a revolutionary new grounding conductor. The Cu-Bond Round Conductor is comprised of an electro-plated coating of copper deposited over a layer of nickel surrounding a steel core. This process helps ensure a long-lasting molecular bond between the copper layer and the steel.

The conductor core consists of a low-carbon steel grade for improved flexibility in the field. The copper surface of the conductor provides high conductivity and corrosion-resistance properties.

FEATURES

- Copper-bonded coating will not crack or tear when the conductor is bent
- High resistance to corrosion and provides a low resistance path to Earth
- Available in standard packaging lengths of 100 meters, 50 meters, and 25 meters
- Minimum copper plating thickness of 254 microns
- Available in nominal diameters of 8, 10, 13, 14, 16, and 18 mm
- Meets the requirements of IEC® 62305-3 Edition 2 and IEC/EN 62561-2 for lightning protection applications
- Cu-Bond Round conductors are UL certified to IEC® 62561-2
- Many sizes of Cu-Bond Round Conductors are listed to UL 467



BENEFITS AS AN ALTERNATIVE TO COPPER CONDUCTOR

- **Theft deterrent:** Copper theft is a problem everywhere. Cu-Bond Round Conductor is hard to cut with hand tools due to its steel core. They are also magnetic, notifying potential thieves that the materials within are of little scrap value.
- **Cost-effective:** Because the copper is bonded to a steel core, the cost of the conductor is minimized by reducing the total amount of copper in the cable.

BENEFITS AS AN ALTERNATIVE TO GALVANIZED STEEL CONDUCTOR

- **Superior corrosion resistance:** In comparison to other steel-based products, Cu-Bond Round Conductor provides excellent application life of typically 30-40 years in most soil conditions.



Equipotential grounding conductor



GT Cadweld connection



Lightning protection

ABOVE GRADE APPLICATIONS

The unique properties of Cu-Bond Round Conductor make it ideal for both horizontal and vertical placement. Above grade, the conductor is well-suited as a lightning-protection conductor when applied in accordance with the IEC 62305-3 Edition 2.0 standard.

• Utility

- Distribution down-lead conductor and assemblies
- Bonding kits for substation fence or equipment ground risers back to the grid

• Commercial and Industrial

- Alternative conductors to solid copper rod and tapes in grounding and lightning protection

• Telecom

- Conductor for connecting equipment ground to ground grid, and riser (down-lead) conductors for tower
- Grounding conductor for datacenter mesh bonding

• Rail

- Trackside bonding conductor and stray current conductor
- Grounding kits for trackside equipment, electrical traction power
- Substation, wayside shelters, communication antenna equipment



Telecom tower grounding

BELOW GRADE APPLICATIONS

Copper-bonded steel conductors are ideal as earthing and bonding conductors where copper theft on-site may occur. Cu-Bond is ideal for use in a variety of applications including power distribution earthing and bonding; substation earthing; commercial, industrial, and railway earthing.

• Buried ground grid conductors and electrodes:

- Wireless telecom tower earthing
- Utility substation earthing; power distribution and transmission earthing
- Large scale ground mount solar farm earthing
- Industrial facility earthing, for example, petro-chemical and mining infrastructure
- Railway earthing
- Interconnecting grounding conductor



Cu-Bond Round Conductor is stamped with compliance markings directly on the product to ensure genuine product and high quality standards. Beware of imitations.

nVENT ERICO CU-BOND ROUND CONDUCTOR

For decades, nVent ERICO has provided the market with high quality copper-bonded ground rods. nVent ERICO has taken that same concept in ground rods and made this into a revolutionary new grounding conductor. The core of the nVent ERICO Cu-Bond Round Conductor is a low carbon steel grade for improved flexibility in the field. The steel core is plated with nickel then electroplated with a coating of copper. This electro-plating process helps ensure a long-lasting molecular bond between the copper layer and the steel. The steel core of the conductor provides theft-deterrent benefits, making the conductor difficult to cut with hand tools. With this steel core, nVent ERICO Cu-Bond Round Conductor is a cost-effective alternative to 100% copper conductor. The copper surface of the conductor provides high conductivity and corrosion resistance properties. Above grade, the unique properties of nVent ERICO Cu-Bond Round Conductor make it ideal for both horizontal and vertical placement. The conductor is well-suited as a lightning protection conductor when applied in accordance with the IEC 62305-3 Edition 2.0 standard. In the utility industry, the product can be used as a distribution down-lead conductor or as part of a bonding kit for substation fences or equipment ground risers back to the grid. In telecom applications, the product can be used to connect an equipment ground to the ground grid, as a riser (down-lead) for towers, or as a grounding conductor for datacenter mesh bonding. They are also well suited for rail applications such as trackside bonding conductors and stray current conductors, grounding kits for trackside equipment, electrical traction power, as well as in substation, wayside shelters, and

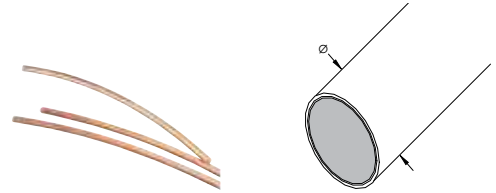

communication antenna equipment. Below grade, nVent ERICO Cu-Bond Round Conductors are ideal as earthing and bonding conductors where copper theft may occur. They may be used as a buried ground grid conductor or electrode for wireless telecom towers, power distribution and transmission grounding in utility substations, large scale ground mount solar farms, petro-chemical and mining infrastructure in industrial facilities, and railway applications. The conductor also can be used as an interconnecting grounding conductor between wind towers or as a grounding grid at the base of a wind tower.

- Theft-deterrent; steel core is hard to cut with hand tools
- Cost-effective; copper bonded to a steel core minimizes the amount of copper in the cable
- Superior corrosion resistance; application life of typically 30-40 years in most soil conditions
- Copper-bonded coating will not crack or tear when the conductor is bent
- High resistance to corrosion and provides a low-resistance path to ground
- nVent ERICO Cu-Bond Round Conductor is marked every meter (3.28') for easy measurement in the field
- Meets the requirements of IEC® 62305-3 Edition 2 and IEC/EN 62561-2 for lightning protection applications
- nVent ERICO Cu-Bond Round Conductors are UL certified to IEC® 62561-2

Material: Copper-Bonded Steel
 Plating Thickness: 254 µm
 Complies With: IEC® 62305-3 Edition 2; IEC® 62561-2; EN 62561-2



Part Number	Diameter	Length	Fusing Capacity Equivalency	nVent ERICO Cadweld Conductor Code	Unit Weight	Certification Details	Certifications
CBSC8	8,0 mm	100 m	25 mm ²	T1	39,0 kg	IEC® 62561-2	UL (IEC)
CBSC10	10,0 mm	100 m	35 mm ²	T2	62,7 kg	IEC® 62561-2	UL (IEC)
CBSC13	13,2 mm	100 m	50 mm ²	T3	107,6 kg	IEC® 62561-2, UL® 467, CSA C22.1 No 41	cULus, UL (IEC)
CBSC14	14,2 mm	100 m	70 mm ²	T4	125,0 kg	IEC® 62561-2, UL® 467, CSA C22.1 No 41	cULus, UL (IEC)
CBSC16	15,7 mm	100 m	80 mm ²	T5	149,6 kg	IEC® 62561-2, UL® 467, CSA C22.1 No 41	cULus, UL (IEC)
CBSC18	17,7 mm	100 m	95 mm ²	T6	192,2 kg	IEC® 62561-2, UL® 467, CSA C22.1 No 41	cULus, UL (IEC)

Resistance per unit length measurements made in mΩ/m, CBSC compared with respect to AWG/Metric.

The IEEE® 837 standard (Annex C) provides a method of calculating the fusing current for conductors. This chart is a reference of the calculations for copper-bonded steel conductor according to the IEEE 837 standard. This information is for reference only.

Conductor Physical Size Comparison		
Conductor Size	Approximate Diameter	Cross Section
25 mm ²	6.76 mm	-
35 mm ²	7.65 mm	-
CBSC8	8.00 mm	50.27 mm ²
50 mm ²	8.89 mm	-
CBSC10	10.00 mm	78.52 mm ²
70 mm ²	10.69 mm	-
95 mm ²	12.47 mm	-
CBSC13	13.20 mm	138.07 mm ²
CBSC14	14.20 mm	158.90 mm ²
120 mm ²	14.22 mm	-
CBSC16	15.70 mm	199.84 mm ²
150 mm ²	15.75 mm	-
185 mm ²	17.65 mm	-
CBSC18	17.70 mm	243.27 mm ²

Conductivity Comparison				
Part Number	AWG (Ω/km)	CBSC Resistance per Length Comparison	mm ² (Ω/km)	CBSC Resistance per Length Comparison
CBSC18	1/0 AWG	118.52%	50 mm ²	110.82%
	2 AWG	74.54%	35 mm ²	77.57%
CBSC16	2 AWG	102.20%	35 mm ²	106.36%
	4 AWG	64.27%	25 mm ²	75.97%
CBSC14	2 AWG	137.78%	25 mm ²	102.42%
	4 AWG	86.65%	16 mm ²	65.55%
CBSC13	2 AWG	134.46%	25 mm ²	99.95%
	4 AWG	84.56%	16 mm ²	63.97%
CBSC10	4 AWG	132.25%	16 mm ²	100.05%
	6 AWG	83.17%	10 mm ²	62.53%
CBSC8	6 AWG	107.85%	16 mm ²	129.73%
	8 AWG	67.83%	10 mm ²	81.08%

Fusing Current I _{rms} (kA) - IEEE® 837 Annex C							
Conductor Type Copper-bonded, ^{Steel Core, Rod} a		CBSC8	CBSC10	CBSC13	CBSC14	CBSC16	CBSC18
Conductor Cross Section in mm ²	A	50.265	78.52	138.07	158.903	199.84	243.27
Initial Conductor Temperature in °C	T _a	40	40	40	40	40	40
Time of Current Flow in Seconds	t _c	2	2	2	2	2	2
Maximum Allowable Temperature in °C	T _m	1084	1084	1084	1084	1084	1084
Thermal Coefficient of Resistivity at Reference Temperature T _r	a _r	0.00378	0.00378	0.00378	0.00378	0.00378	0.00378
Resistivity of the Ground Conductor at Reference Temperature T _r in mΩ-cm	r _r	8.621	8.621	8.621	8.621	8.621	8.621
^{1/a₀} or (1/ a _r) - T _r in °C	K ₀	245	245	245	245	245	245
Thermal Capacity Factor in Joules/cm ³ /°C	TCAP	3.846	3.846	3.846	3.846	3.846	3.846
Material Conductivity (%)	%	24.5	20.4	18.8	15.9	16.3	17.7
Fusing Current Calculation	β	84.73	84.73	84.73	84.73	84.73	84.73
	I	4.79	7.48	13.16	15.15	19.05	23.19
	I _{90%}	4.31	6.74	11.84	13.63	17.14	20.87
	I _{80%}	3.83	5.99	10.53	12.12	15.24	18.55

Resistance per unit length measurements made in mΩ/m, CBSC compared with respect to AWG/Metric. The IEEE® 837 standard (Annex C) provides a method of calculating the fusing current for conductors. This chart is a reference of the calculations for copper-bonded steel conductor according to the IEEE 837 standard. This information is for reference only.

nVENT ERICO CU-BOND ROUND CONDUCTOR MANUAL STRAIGHTENING TOOL

FEATURE

- Hand tool used to reduce curvature in nVent ERICO Cu-Bond Round Conductor
- Can be used with nVent ERICO Cu-Bond Round Conductors CBSC8, CBSC10, and CBSC13



Part Number	Length
EGRA15	1,359 mm

INSULATED COPPER CONDUCTOR

FEATURE

- Insulated copper conductor is compacted, so the diameter is smaller than conventional insulated copper conductor
- Green and yellow insulation protects the strands of the conductor

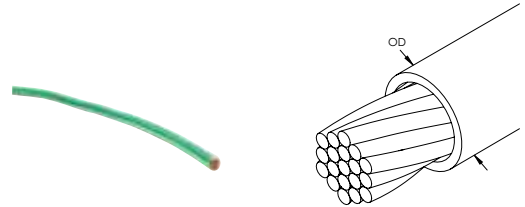

Material: Copper, Polyvinylchloride
 Conductor Type: Concentric, Compacted

Part Number	Conductor Size	Number of Wires	Wire Diameter	Cable Diameter	Outer Diameter	Cable Length	Insulation Thickness	Unit Weight
ICECH50C	50 mm ² Stranded	10	2.67 mm	8.15 mm	11.0 mm	50 m	1 mm	26 kg
ICECH70C	70 mm ² Stranded	14	2.67 mm	9.65 mm	12.5 mm	500 m	1 mm	360 kg

Outer diameter dimensions are approximate.

NON-INSULATED SOLID CONDUCTOR

FEATURE

- Solid cable for a variety of applications
- Available in smaller spool sizes for convenience
- LPA and LPC parts are used for lightning protection system downconductor or grounding applications

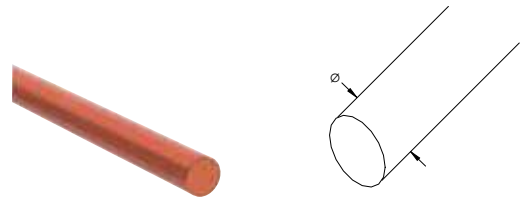

Part Number	Article Number	Conductor Size	Cross Section	Diameter	Length	Unit Weight	Complies With
Material: Aluminum – Finish: Bare							
RSCCA830	197698	1/0 Solid	50.3 mm ²	8 mm	30 m	0.140 kg	
ASC0850	711530	1/0 Solid	50.3 mm ²	8 mm	50 m	0.140 kg	
RSCCA1330	197705	5/0 Solid	132.7 mm ²	13 mm	30 m	0.359 kg	
RSCCA1350	197706	5/0 Solid	132.7 mm ²	13 mm	50 m	0.359 kg	

Part Number	Article Number	Conductor Size	Cross Section	Diameter	Length	Unit Weight	Complies With
Material: Copper – Finish: Bare							
RC-EC-8	198160	1/0 Solid	50.2 mm ²	8 mm	100 m	0.449 kg	IEC® EN 62561-2
RCEC6	198150	6 mm ² Solid	28.3 mm ²	6 mm	100 m	0.250 kg	
Material: Copper – Finish: Tinned							
RC-ET-8	198210	1/0 Solid	50.2 mm ²	8 mm	100 m	0.449 kg	
Material: Stainless Steel 304 (EN 1.4301) – Finish: Bare							
RSCC2SS830	197685	1/0 Solid	50.3 mm ²	8 mm	30 m	0.400 kg	
RSCC2SS850	197686	1/0 Solid	50.3 mm ²	8 mm	50 m	0.400 kg	
Material: Stainless Steel 316L (EN 1.4404) – Finish: Bare							
RSCC4SS830	197692	1/0 Solid	50.3 mm ²	8 mm	30 m	0.400 kg	
RSCC4SS850	197693	1/0 Solid	50.3 mm ²	8 mm	50 m	0.400 kg	
RSCC4SS1030	197695	3/0 Solid	78.6 mm ²	10 mm	30 m	0.630 kg	
RSCC4SS1050	197696	3/0 Solid	78.6 mm ²	10 mm	50 m	0.630 kg	
Material: Steel – Finish: Hot-Dip Galvanized							
RSCC8100	197860	1/0 Solid	50.3 mm ²	8 mm	125 m	0.400 kg	
RSCC1030	197682	3/0 Solid	78.5 mm ²	10 mm	30 m	0.630 kg	
RSCC1050	197683	3/0 Solid	78.5 mm ²	10 mm	50 m	0.630 kg	

Unit weight is per foot (0.3048 m). Cut-to-order (CTO) lengths are available for an additional charge.

TAPE CONDUCTOR

FEATURE

- Lower impedance than equivalent sized round conductor
- Used for lightning protection system downconductor or grounding applications

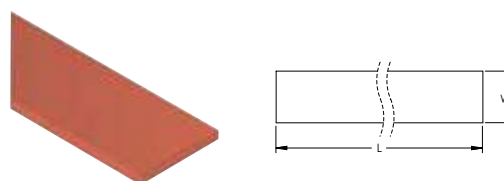

Part Number	Article Number	Width	Thickness	Length	Unit Weight	Complies With
Material: Aluminum – Finish: Bare						
FAT-253-50	710740	25.0 mm	3.0 mm	50.0 m	0.210 kg	
Material: Copper – Finish: Bare						
TCEC25230	197656	25.0 mm	2.0 mm	30.0 m	0.445 kg	
TCEC25250	197657	25.0 mm	2.0 mm	50.0 m	0.445 kg	
TCEC25325	710515	25.0 mm	3.0 mm	25.0 m	0.671 kg	IEC® EN 62561-2
TC-EC-2530-50	710510	25.0 mm	3.0 mm	50.0 m	0.671 kg	IEC® EN 62561-2
TCEC25430	197662	25.0 mm	4.0 mm	30.0 m	0.890 kg	
TCEC25450	710520	25.0 mm	4.0 mm	50.0 m	0.890 kg	
TCEC30230	197650	30.0 mm	2.0 mm	30.0 m	0.530 kg	
TCEC30250	197652	30.0 mm	2.0 mm	50.0 m	0.530 kg	
TCEC38510	710555	38.0 mm	5.0 mm	10.0 m	1.700 kg	
TCEC38630	710560	38.0 mm	6.0 mm	30.0 m	2.040 kg	
TCEC405030	-	40.0 mm	5.0 mm	30.0 m	1.780 kg	
TCEC50430	197665	50.0 mm	4.0 mm	30.0 m	1.780 kg	
TCEC50450	197666	50.0 mm	4.0 mm	50.0 m	1.780 kg	
TCEC50620	710580	50.0 mm	6.0 mm	20.0 m	2.670 kg	
TCEC50630	197668	50.0 mm	6.0 mm	30.0 m	2.670 kg	
TCEC50650	197669	50.0 mm	6.0 mm	50.0 m	2.670 kg	
A811A26F500	-	50.8 mm	0.4 mm	152.4 m	0.226 kg	

Part Number	Article Number	Width	Thickness	Length	Unit Weight	Complies With
Material: Copper – Finish: Lead Covered						
LCT25350	710625	25.0 mm	3.0 mm	25.0 m	2.560 kg	
Material: Copper – Finish: Tinned						
TCECT25230	197659	25.0 mm	2.0 mm	30.0 m	0.450 kg	
TCECT25250	197661	25.0 mm	2.0 mm	50.0 m	0.450 kg	
TC-ECT-253	197720	25.0 mm	3.0 mm	30.0 m	0.670 kg	IEC® EN 62561-2
TCECT25350	197715	25.0 mm	3.0 mm	50.0 m	0.670 kg	IEC® EN 62561-2
TCECT30230	197710	30.0 mm	2.0 mm	30.0 m	0.530 kg	IEC® EN 62561-2
TCECT30250	197654	30.0 mm	2.0 mm	50.0 m	0.530 kg	
TCECT30275	545200	30.0 mm	2.0 mm	75.0 m	0.530 kg	IEC® EN 62561-2
TCECT3850	–	38.0 mm	5.0 mm	30.0 m	1.700 kg	
TCECT5060	–	50.0 mm	6.0 mm	20.0 m	2.680 kg	IEC® EN 62561-2
Material: Stainless Steel 304 (EN 1.4301) – Finish: Bare						
TCHSSP303530	197674	30.0 mm	3.5 mm	30.0 m	0.840 kg	
TCHSSP303550	197675	30.0 mm	3.5 mm	50.0 m	0.840 kg	
Material: Stainless Steel 316L (EN 1.4404) – Finish: Bare						
TCHSS303530	197676	30.0 mm	3.5 mm	30.0 m	0.840 kg	
TCHSS303550	197677	30.0 mm	3.5 mm	50.0 m	0.840 kg	
Material: Steel – Finish: Hot-Dip Galvanized						
TCHGSP303530	197810	30.0 mm	3.5 mm	30.0 m	0.820 kg	
TCHGSP303550	197672	30.0 mm	3.5 mm	50.0 m	0.840 kg	
TCHGS40430	197890	40.0 mm	4.0 mm	30.0 m	1.292 kg	

Cut-to-order (CTO) lengths are available for an additional charge. Unit weight is per meter (3.28').

LOW IMPEDANCE RISER

FEATURE

- Used to connect the signal reference grid to equipment
- Welded to the SRG using nVent ERICO Cadweld mold type TW
- Has a lower impedance than a 4/0 AWG copper conductor

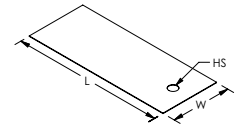
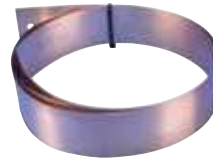

Material: Copper

Part Number	Length	Width	Thickness	Hole Size
B802D01A72	1,829 mm	50 mm	0.4 mm	7.9 mm

Grounding and Bonding

nVENT ERICO GROUND ENHANCEMENT MATERIAL (GEM)



Ground Enhancement Material (GEM) is a superior conductive material that solves your toughest grounding problems. It is the ideal material to use in areas of poor conductivity, such as rocky ground, mountain tops and sandy soil. GEM dramatically reduces earth resistance and impedance measurements. Furthermore, GEM may reduce the size of the grounding system where conventional methods are unsatisfactory. Once installed, GEM is maintenance-free, not requiring periodic charging or the presence of water to maintain its conductivity. Third-party testing has been completed to verify that GEM conforms to IEC® 62561-7. This standard introduces a benchmark for electrical performance and corrosion of earth enhancement materials that has been absent from the industry to date. nVent ERICO offers GEM Calculator software that provides resistivity values for common GEM applications and can help estimate the amount of GEM required for an installation. It operates in four languages - English, Spanish, French and German - and performs calculations in Imperial or Metric units. The GEM Calculator is available for download on our website at erico.com.

Unit Weight: 11.36 kg

FEATURE

- Maintains constant resistance for the life of the system once in its set form
- Performs in all soil conditions even during dry spells
- Does not require periodic charging treatments or placement
- Does not require the continuous presence of water to maintain its conductivity
- Fully sets within 3 days, fully cures within 28 days
- Does not dissolve, decompose, or leach out with time
- Non-corrosive
- Reduces vandalism and theft since conductors are hard to remove from concrete
- Easy-to-handle 25 lb (11.3kg) bags or buckets
- Requires only one person to install
- Exceeds IEC® 62561-7 which sets the benchmark for corrosion, leaching, sulfur content, and other environmental regulations
- Complies to the U.S. Environmental Protection Agency (EPA) Toxicity Characteristic Leaching Procedure (TCLP), EPA test method 1311
- Can be installed using trench or ground rod backfill methods

Part Number	Article Number	Packaging	Complies With
GEM25A	163670	Bag with handles	IEC® 62561-7
GEM25ABKT	–	Plastic bucket with locking lid	IEC® 62561-7

Suggested Specifications		
Parameter	Recommended Values	Test Method
Standards Compliance		Full compliance to IEC 62561-7 EPA Toxicity Characteristic Leaching Procedure (TCLP), test method 1311
Leaching	Arsenic < 1.5 mg/L, Barium < 60 mg/L, Cadmium < 0.15 mg/L, Chromium < 3.0 mg/L, Lead < 1.5 mg/L, Mercury < 0.06 mg/L, Elenium < 1.0 mg/L	EC 62561-7 EN 12457-2
Sulfur Content	< 2%	ISO 14869-1
Resistivity	<2 Ω-cm for powder <20 Ω-cm for mixed and cured material	Compressed powder according to ASTM G187-12 Mixed and cured per ASTM D991-89
Corrosion Performance	For copper-plated earth electrodes, the polarization resistance shall be IEC 62561-7, Sec 5.5, aggressive environment erico.com 3 Suggested Specifications > 8 Ω x m2 for aggressive environments For galvanized earth electrodes, the polarization resistance shall be > 7.6Ω x m2 for aggressive environments	IEC 62561-7, Sec 5.5, aggressive environment
Flexural Strength	300-450 psi [2070-3100 kPa]	ASTM C293
Compressive Strength	100-200 psi [690-1390 kPa] after 672 hours curing time	ASTM C109

Estimated Linear Feet of Ground Conductor Covering with Each Bag of GEM							
Trench Width		Total Thickness of GEM					
		in	cm	in	cm	in	cm
Inches	Centimeters						
4	10	3.5	1.0m	2.8	0.8m	2.3	0.7m
6	15.2	9.3	0.7m	1.8	0.5m	1.5	0.4m
8	20.3	7	0.5m	1.4	0.4m	1.1	0.3m
10	25.4	5.6	0.4m	1.1	0.3m	0.9	0.3m
12	30.5	4.7	0.3m	0.9	0.3m	0.7	0.2m

Estimated Bags of GEM for Backfilling Around Ground Rods to a Density of 63.5 lb/ft ³ (1,017 kg/m ³)													
Diameter of Hole		ft	m	ft	m	ft	m	ft	m	ft	m	ft	m
		5	1.5	6	1.8	8	2.4	10	3	15	4.6	20	6.1
Inches	Centimeters												
4	10.2	2		2		2		3		4		5	
6	15.2	3		3		4		5		8		10	
8	20.3	5		6		8		9		14		18	
10	25.4	7		9		12		14		21		28	
12	30.5	10		12		16		20		30		40	

NVENT ERICO QUICKFILL NO-MIX GROUND ENHANCING BACKFILL – QF25

FEATURE

- Lowers system resistance to ground
- Low-dust formulation
- Water not needed to install or perform
- Fast installation with no mixing or cure time required
- Can be installed in below-freezing temperatures
- Does not dissolve, decompose, or leach out with time
- Corrosion-resistant
- Sulfur content below 2% per IEC 62561-7
- Easy-to-handle 25 lb (11.3 kg) bags
- Requires only one person to install
- Resistance measurements can be taken immediately after installation
- Complies to the U.S. Environmental Protection Agency (EPA) Toxicity Characteristic Leaching Procedure (TCLP), EPA test method 1311
- Complies to EN 12457-2 Characterization of Waste Leaching Procedure, ENV 12506 and ENV 13370



nVent ERICO Quickfill is a no-mix ground-enhancing backfill that reduces resistance to ground and enables convenient installations. Quickfill is designed to minimize dust and eliminate mixing. It is the ideal material to use in areas of poor conductivity such as rocky ground, mountain tops, and sandy soil. Once installed, Quickfill is maintenance-free, not requiring periodic charging.

Dry ground enhancement materials are more sensitive to seasonal variability than cement-based materials.



Unit Weight: 11.3 kg

Part Number	Quantité Standard d'Emballage	UPC	EAN-13
QF25	1 pc	78285695596	0782856955962

Specifications

Parameter	Values	Test Method
Resistivity	< 15 Ω-cm when mixed with 40% water by weight < 25 Ω-cm when tested dry	4-Electrode method per ASTM G57-06
Sulfur Content	< 2%	ISO 4689-3
Leaching	< reporting limit for all substances	EN 12457-2 TCLP per EPA 1311
Density	993 kg/m ³	-

Estimated Trench Length per Bag of Quickfill

Trench Width	Total Thickness of Quickfill		
	10 cm	13 cm	15 cm
10 cm	1.10 m	0.88 m	0.73 m
15 cm	0.73 m	0.58 m	0.49 m
20 cm	0.55 m	0.43 m	0.37 m
25 cm	0.43 m	0.34 m	0.27 m
30 cm	0.37 m	0.27 m	0.24 m

Estimated Bags of Quickfill for Backfilling Around Ground Rods

Diameter	Depth					
	1.5 m	1.8 m	2.4 m	3.0 m	4.6 m	6.1 m
10 cm	1.1	1.3	1.8	2.2	3.3	4.4
15 cm	2.5	3.0	3.9	4.9	7.4	9.8
20 cm	4.4	5.2	7.0	8.7	13.0	17.4
25 cm	6.8	8.2	10.9	13.6	20.3	27.1
30 cm	9.8	11.7	15.6	19.5	29.3	39.0

INSPECTION HOUSING, HIGH DENSITY POLYETHYLENE (HDPE)

FEATURE

- Pedestrian load rating
- Suitable for lighter load rating applications in turf
- Chemical, UV and corrosion resistant
- 3/8" x 2 1/2" (64 mm) stainless steel lock bolt included
- Boxes and covers nest in 3 1/4" (83 mm) increments
- Two 3 1/2" x 1 1/2" (89 x 38 mm) knockouts per box
- T416BH includes four additional holes in the cover to allow water to enter the inspection well, typically for use with chemical ground rods

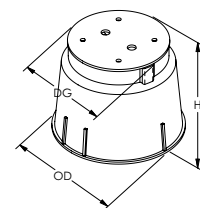

Material: High Density Polyethylene (HDPE)
Color: Green
Load Rating: 0.15 kg/cm²

Part Number	Diameter, Grade Level	Outer Diameter	Height	Unit Weight
T416B	260 mm	333 mm	254 mm	2 kg

INSPECTION HOUSING WITH CONDUIT CUTOUT, HIGH DENSITY POLYETHYLENE (HDPE)

FEATURE

- Suitable for lighter load rating applications in turf
- Chemical, UV and corrosion resistant

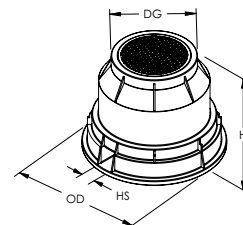

Material: High Density Polyethylene (HDPE)
Color: Black
Load Rating: 0.15 kg/cm²

Part Number	Diameter, Grade Level	Outer Diameter	Height	Hole Size	Unit Weight
T416C	362 mm	619 mm	464 mm	70 mm	7.3 kg

INSPECTION HOUSING, POLYOLEFIN

FEATURE

- Lightweight design and multiple handholes allow for easy handling and installation by one person
- Durable, single-piece body engineered to resist bowing during installation and withstand heavy loads
- Unique material blend resists chipping and cracking
- Tier 15 Design Load of 15,000 lbs (6,804 kg) with a test load of 22,500 lbs (10,206 kg)



Material: Polyolefin

Part Number	Height	Length	Width	Unit Weight
IH1250D	305 mm	305 mm	305 mm	5.58 kg
IH1250F	584 mm	305 mm	305 mm	17.28 kg
IH1324A	457 mm	610 mm	330 mm	11.75 kg
IH2600E	457 mm	305 mm	305 mm	7.67 kg

INSPECTION HOUSING, HIGH-IMPACT POLYPROPYLENE

FEATURE

- Offers a high level of protection for critical grounding terminations through the use of its lockable lid
- Easy-locking lid only opened with security key
- Ease of ground termination maintenance due to large working aperture
- Lightweight design allows easy handling, storage and transportation
- Suitable for both paving and hot tar applications
- UV-stabilized against degradation by sunlight
- Non-brittle to prevent cold weather damage
- Base designed to accommodate Grounding Busbar for Inspection Housing (545135)

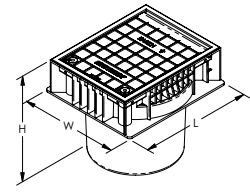

Material: High-Impact Polypropylene

Part Number	Article Number	Height	Length	Width	Unit Weight
PIT03	710180	216 mm	241 mm	207 mm	1.3 kg

INSPECTION HOUSING, CONCRETE

FEATURE

- Concrete design for higher load rating
- Available with a central lifting hook
- Flush-fitting lid with plain surface minimizes slipping
- Suitable for most grounding and lightning protection installations
- Base designed to accept 545140 Grounding Busbar for Inspection Housings
- Square shape

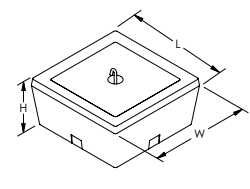

Material: Concrete
Color: Gray

Part Number	Article Number	Height	Length	Width	Unit Weight
IP900C	103450	152 mm	330 mm	330 mm	25.9 kg

INSPECTION HOUSING, SEAL KIT

FEATURE

- Prevents the ingress of ground water into and surrounding the inspection housing
- Waterproofing is achieved by enclosing an upper section of copper-bonded ground rod within a plastic pipe with seals located on both sides of the concrete pour
- The two plate-style flange serves to reduce pressure, which may occur from the capillary effect of water on the outside of the seal and inspection housing
- The flanges are intended to prevent water pressure from "popping" the inspection pit out of the concrete
- Delivered as a kit, including a 3.9 foot (1.2 meter) PVC pipe, to be adjusted to site conditions
- Earth seal can be used with 5/8" (15.9 mm) ground rod only

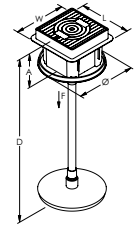

Material: Thermoplastic

Part Number	Article Number	Length	Width	Depth	A	Diameter	Water Pressure	Working Load	Unit Weight
WGRS200	158922	248 mm	248 mm	1.4 m	210 mm	350 mm	550 kPa Max	6,000 kgf	4.3 kg

GROUNDING BUSBAR FOR INSPECTION HOUSING

FEATURE

- Grounding busbar for use in conjunction with ground rod inspection housings

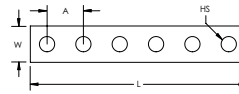

Material: Copper

Part Number	Length	Width	Thickness	A	Hole Size	Number of Holes	Inspection Housing	Unit Weight
545530	150 mm	25 mm	5 mm	25 mm	10.5 mm	6	103470, 103480	0.167 kg
545135	200 mm	25 mm	5 mm	25 mm	10.5 mm	8	PIT03	0.222 kg
545140	300 mm	25 mm	5 mm	25 mm	10.5 mm	12	IP-900-C	0.333 kg

GROUND MESH

FEATURE

- Prefabricated ground mesh wound into a roll format for shipping
- Silver brazed joints (35% silver alloy brazing material) provide strength to resist separation during installation and bear the traffic of heavy vehicles
- Conductor spacing in many rectangular configurations up to 24" x 48" (610 mm x 1219 mm) in 2" (51 mm) increments
- Normally supplied in sections with standard overhang for interconnecting half conductor spacing + 2" (51 mm)

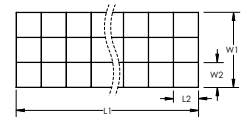
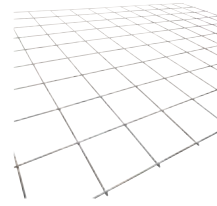

Material: Copper, Copper-Bonded Steel

Part Number	Length 2	Width 1	Width 2	Conductor Size	Overhang	Unit Weight
MESH	51 – 610 mm	6.1 m Max	51 – 1,219 mm	#6 Solid Copper, #6 Copper-Clad Steel (30% or 40% Conductivity), #8 Solid Copper, #8 Copper-Clad Steel (30% or 40% Conductivity), #10 Solid Copper	Standard: Half Conductor Spacing + 2" (51 mm), None, Half Conductor Spacing	227 kg Max

Net Weight (kg) per 93 Square Meters (1,000 Square Feet)						
Conductor Spacing (W2 x L2)	Copper-clad Steel Conductor (AWG)			Solid Copper Wire (AWG)		
	#6	#8	#10	#6	#8	#10
51 mm x 51 mm	403 kg	253 kg	159 kg	442 kg	276 kg	174 kg
102 mm x 102 mm	201 kg	127 kg	79 kg	221 kg	138 kg	87 kg
152 mm x 152 mm	134 kg	84 kg	53 kg	147 kg	92 kg	58 kg
203 mm x 203 mm	101 kg	63 kg	40 kg	110 kg	69 kg	44 kg
305 mm x 305 mm	67 kg	42 kg	27 kg	74 kg	46 kg	29 kg
610 mm x 610 mm	34 kg	21 kg	13 kg	41 kg	23 kg	15 kg

Add 34 kg per roll for approximate shipping weight.

Length 1 (L1) is unlimited, up to 500 lbs. (227 kg) maximum. Length 2 (L2) and Width 2 (W2) are available in 2" (51 mm) increments only.

SIGNAL REFERENCE GRID

FEATURE

- Provides a low impedance equipotential plane to protect sensitive electronic equipment from transient noise
- Pre-engineered welded grid of 26 gauge copper strips reduces voltage differences between interconnected electronic equipment
- Welded connections do not deteriorate, corrode or loosen with time
- Can be easily field-welded to suit any size computer room
- Complies with IEEE® Standard 1100-1992

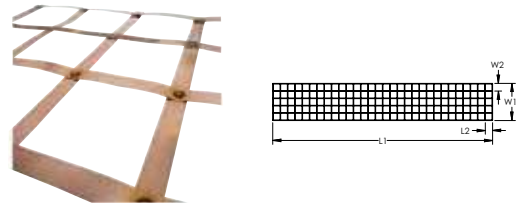

Material: Copper



Part Number	Article Number	Length 1	Width 1	Grid Spacing	Thickness	Strip Width
167900	167900	36,570 mm	2.4 m	610 mm x 610 mm	0.4 mm	50.4 mm
SRGBD100	167901	30,500 mm	3.0 m	610 mm x 610 mm	0.4 mm	50.4 mm
SRGBE100	167902	30,480 mm	3.7 m	610 mm x 610 mm	0.4 mm	50.4 mm
SRGBG100	167904	30,480 mm	4.9 m	610 mm x 610 mm	0.4 mm	50.4 mm

Custom sizes available upon request. Contact your nVent ERICO representative for more information.

COPPER GROUND PLATE

FEATURE

- Provides a large surface area to dissipate current into the ground
- Available in a variety of sizes and pigtail configurations



GPE-C-E-A-H-024-1L-024-(T)		
GPE	Ground Plate Electrode	
C	Material	A: Steel (HRS M1020) B: Stainless Steel (SS304) C: Copper (C11000) D: Galvanized Steel
E	Pigtail Connection	C: Continuous (2 x "L J" nVent ERICO CADWELD Connection) E: End ("L J" nVent ERICO CADWELD Connection Style) N: No Pigtail
A	Plate Thickness Code (Stock Tolerance)	A: 1/32" (Min. for Lightning – Cu) B: 1/16" (Min. for Power – Cu) C: 3/32" D: 1/8" E: 1/4" (Min. for Power – Stl.) F: 3/8" G: 1/2" H: 1/64" (26 GA) J: 3/16"
H	Plate Width Code	A: 1" · B: 2" · C: 3" · D: 4" · E: 5" · F: 6" · G: 9" · H: 12" · J: 18" K: 24" · L: 30" · M: 36" · N: 42" · P: 48" · Q: 17" · R: 10"
24	Plate Length Code (inches) (3 digits required)	
1L*	Pigtail Cable Type (nVent ERICO Cable Code)	
024*	Pigtail Length (inches)	
(T)*	Tinned	

* Empty if none

Pigtail Connection

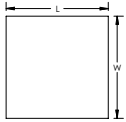

None

Material: Copper

Part Number	Width	Length	Pigtail Connection	Pigtail Length	Conductor Size	Thickness
710190	600 mm	600 mm	None	-	-	1.5 mm
710200	600 mm	600 mm	None	-	-	3.0 mm
710210	900 mm	900 mm	None	-	-	1.5 mm
504590	900 mm	900 mm	None	-	-	3.0 mm
504550	1,000 mm	2,000 mm	None	-	-	2.0 mm

B162 EARTHPOINT, TWO STUD

FEATURE

- Long-lasting design
- Low ground resistance and impedance
- Superior electrical conductivity and resistance to corrosion
- Electrically and mechanically robust and reliable
- Easy to install as a Prefabricated Earthbridge once nVent ERICO Cadweld welded to a piece of conductor

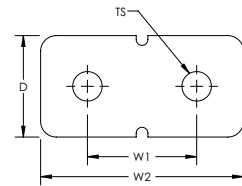
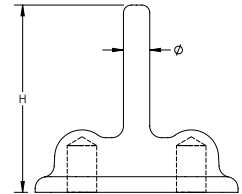

Material: Brass

Part Number	Width 1	Width 2	Depth	Height	Diameter	Thread Size
B1622Q	44.5 mm	82.6 mm	41.28 mm	76.2 mm	13.5 mm	1/2 UNC

Assemblies require conductors and nVent ERICO Cadweld connections, which must be ordered separately.

B161/B164 EARTHPOINT, FOUR STUD

FEATURE

- Long-lasting design
- Low ground resistance and impedance
- Superior electrical conductivity and resistance to corrosion
- Electrically and mechanically robust and reliable
- Easy to install as a Prefabricated Earthbridge once nVent ERICO Cadweld welded to a piece of conductor

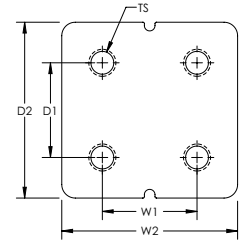
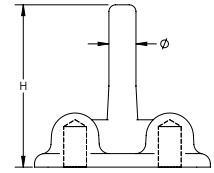

Material: Copper

Part Number	Article Number	Width 1	Width 2	Depth 1	Depth 2	Height	Diameter	Thread Size
B16110B	166030	30.0 mm	65 mm	30.0 mm	65 mm	42 mm	14.0 mm	M10
B16412A	166060	44.5 mm	85 mm	44.5 mm	85 mm	70 mm	10.7 mm	M12

Assemblies require conductors and nVent ERICO Cadweld connections, which must be ordered separately.

GROUND POINT

FEATURE

- Cast grounding plate for equipment, machinery, or structure grounding points
- May be installed flush in concrete floor or wall
- Cable connection under bolt tension

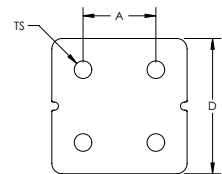
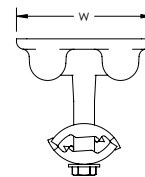

Material: Brass

Part Number	Conductor Size, UL	Thread Size	Depth	Width	A	Unit Weight
LPC682	Class 1 - Class 2 (4/0 Max)	1/2 UNC	82.55 mm	82.55 mm	44.45 mm	0.696 kg

AIRCRAFT GROUNDING RECEPTACLE WITH BAR ATTACHMENT POINT

FEATURE

- Castings for use in static grounding systems of refueling areas
- Suitable as a combination tie down and static ground point
- Easily connected to grounding system conductor and/or ground rods
- Designed for simple installation with flush paved surfaces
- Compatible with nVent ERICO Cadweld connections

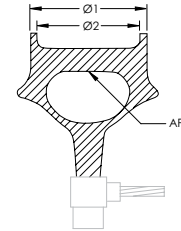
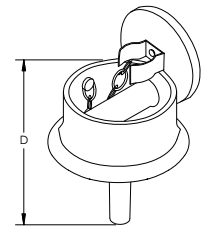

Material: Phosphor Bronze

Part Number	Article Number	Diameter 1	Diameter 2	Depth	Attachment Point	Pipe Size	Connection Type
B166	165220	98 mm	92 mm	158.8 mm	19 mm Diameter Bar	1/2"	RA, RB
B167	165230	120 mm	112 mm	184.2 mm	38 mm Diameter Bar	1/2"	RA, RB

AIRCRAFT GROUNDING RECEPTACLE WITH BALL STUD

FEATURE

- Castings for use in static grounding systems of refueling areas
- Easily connected to grounding system conductor and/or ground rods
- Designed for simple installation with flush paved surfaces
- Compatible with nVent ERICO Cadweld connections

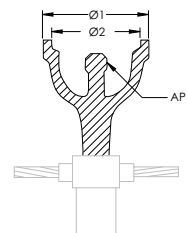
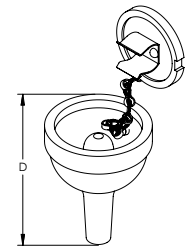

Material: Phosphor Bronze

Part Number	Article Number	Diameter 1	Diameter 2	Depth	Attachment Point	Pipe Size	Connection Type
B165	165180	69.9 mm	55.6 mm	114.3 mm	Permanent 16 mm Ball Stud	1/2"	RA, RB
B165R	-	69.9 mm	55.6 mm	114.3 mm	Removable 16 mm Ball Stud	1/2"	RA, RB

AIRCRAFT GROUNDING RECEPTACLE FOR THREADED GROUND RODS

FEATURE

- Castings for use in static grounding systems of refueling areas
- Designed for simple installation with flush paved surfaces
- Standard pin connection
- Chain-retained cover plate
- Couple directly to 3/4" (nominal) threaded or extension rod
- LPC681 includes spring clip to secure the cover plate

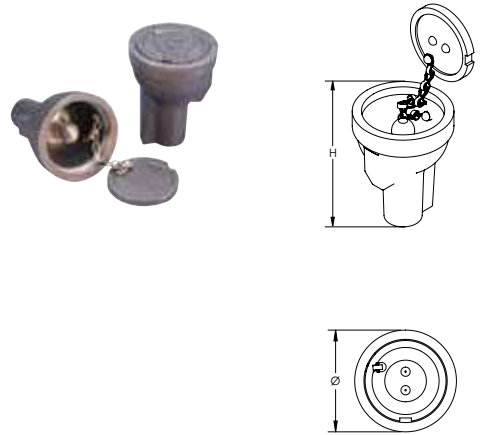

Material: Bronze

Part Number	Diameter	Height	Attachment Point	Spring Clip Included
LPC680	69.9 mm	88.9 mm	Permanent 19 mm Ball Stud	No
LPC681	69.9 mm	88.9 mm	Permanent 19 mm Ball Stud	Yes

AIRCRAFT GROUNDING TIE DOWN

FEATURE

- Used as an attachment point for static grounding
- Complies with UL 467



Material: Copper-Bonded Steel, Bronze

Part Number	Diameter	Length	Thread Size	A	B
663400	50.8 mm	3,048 mm	3/4 UNC	127 mm	25.4 mm

AIRCRAFT GROUNDING TIE DOWN MOLD

FEATURE

- Plastic mold for making depression in concrete pour around loop in Aircraft Grounding Tie Down

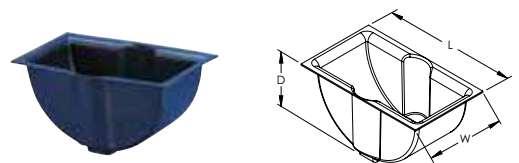

Material: High-Impact Polystyrene

Part Number	Length	Width	Depth
DM5834	152 mm	76 mm	74 mm

AIRCRAFT GROUNDING CLAMP

FEATURE

- Fits ground rods up to 3/4" nominal and nVent ERICO Aircraft Grounding Receptacles B165 and B166
- Cast aluminum construction with plated steel jaws
- Aviation industry standard for bonding and grounding aircraft and refueling vehicles
- Ideal for attaching to landing gear, posts, ground balls, ground rods and other curved unpainted surfaces
- Complies with Mil Spec M83413/7-1



Material: Aluminum, Steel

Part Number	Article Number	Jaw Opening	Throat Depth	Harness Included
B2617A	165620	19 mm Max	19.2 mm	No

STATIC GROUNDING CLAMP FOR DRUMS

FEATURE

- Designed specifically for grounding or bonding small containers, drums, totes, machinery or personnel in areas containing flammable liquids or dust
- Plier-type clamp has a die cast aluminum body with two stainless steel points and a hefty 55 pound (25 kg) spring compression
- Design allows the clamp to penetrate multiple layers of paint or corrosion build-up so that proper contact is made to bare metal



Material: Aluminum, Stainless Steel 416 (EN 1.4005)



Part Number	Article Number	Jaw Opening	Throat Depth	Harness Included
B2610A	165410	25.4 mm Max	25.4 mm	No

STATIC GROUNDING CABLE REEL, BARE CABLE

FEATURE

- Includes a stop at the end of the retractable cable
- Includes removable clamp at the end of the retractable cable
- Typically used with B2610A Static Grounding Clamp For Drums (sold separately)



Material: Steel
Finish: Electrogalvanized

Part Number	Product	Diameter	Length
B2618B	Cable for grounding tanker trucks and rail cars	2.4 mm	15.2 m

Containers with flammable liquid should remain closed until bonding and grounding is complete, because an initial spark may occur during the connection of grounding equipment which could ignite vapors or gases.

Grounding Busbars

ELECTRICAL EARTH BAR

FEATURE

- Provides a convenient, single-point grounding and bonding location
- Busbars with disconnect links allow for convenient testing of the earth termination system
- High conductivity, hard drawn, electrolytic tough pitch copper per EN 13601
- Includes halogen-free polyamide insulators, stainless steel (EN 1.4401) hardware and mounting brackets
- Custom bars can be designed and manufactured to customer specifications

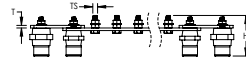

Material: Copper

Part Number	Number of Connections	Number of Disconnects	Thread Size	Height	Length	Width 1	Width 2	Thickness	A
Finish: Bare									
EEB04C506D0A	4	0	M10	94 mm	300 mm	100 mm	50 mm	6 mm	50 mm
EEB04C506D1A	4	1	M10	94 mm	375 mm	100 mm	50 mm	6 mm	50 mm
EEB04C506D2A	4	2	M10	94 mm	450 mm	100 mm	50 mm	6 mm	50 mm
EEB06C506D0A	6	0	M10	94 mm	400 mm	100 mm	50 mm	6 mm	50 mm
EEB06C506D1A	6	1	M10	94 mm	475 mm	100 mm	50 mm	6 mm	50 mm
EEB06C506D2A	6	2	M10	94 mm	550 mm	100 mm	50 mm	6 mm	50 mm
EEB08C506D0A	8	0	M10	94 mm	500 mm	100 mm	50 mm	6 mm	50 mm
EEB08C506D1A	8	1	M10	94 mm	575 mm	100 mm	50 mm	6 mm	50 mm
EEB08C506D2A	8	2	M10	94 mm	650 mm	100 mm	50 mm	6 mm	50 mm
EEB10C506D0A	10	0	M10	94 mm	600 mm	100 mm	50 mm	6 mm	50 mm
EEB10C506D1A	10	1	M10	94 mm	675 mm	100 mm	50 mm	6 mm	50 mm
EEB10C506D2A	10	2	M10	94 mm	750 mm	100 mm	50 mm	6 mm	50 mm
EEB12C506D0A	12	0	M10	94 mm	700 mm	100 mm	50 mm	6 mm	50 mm
EEB12C506D1A	12	1	M10	94 mm	775 mm	100 mm	50 mm	6 mm	50 mm
EEB12C506D2A	12	2	M10	94 mm	850 mm	100 mm	50 mm	6 mm	50 mm
EEB14C506D0A	14	0	M10	94 mm	850 mm	100 mm	50 mm	6 mm	50 mm
EEB14C506D1A	14	1	M10	94 mm	925 mm	100 mm	50 mm	6 mm	50 mm
EEB14C506D2A	14	2	M10	94 mm	1,000 mm	100 mm	50 mm	6 mm	50 mm
EEB16C506D0A	16	0	M10	94 mm	950 mm	100 mm	50 mm	6 mm	50 mm
EEB16C506D1A	16	1	M10	94 mm	1,025 mm	100 mm	50 mm	6 mm	50 mm
EEB16C506D2A	16	2	M10	94 mm	1,100 mm	100 mm	50 mm	6 mm	50 mm
EEB18C506D0A	18	0	M10	94 mm	1,050 mm	100 mm	50 mm	6 mm	50 mm
EEB18C506D1A	18	1	M10	94 mm	1,125 mm	100 mm	50 mm	6 mm	50 mm
EEB18C506D2A	18	2	M10	94 mm	1,200 mm	100 mm	50 mm	6 mm	50 mm
EEB20C506D0A	20	0	M10	94 mm	1,150 mm	100 mm	50 mm	6 mm	50 mm
EEB20C506D1A	20	1	M10	94 mm	1,225 mm	100 mm	50 mm	6 mm	50 mm
EEB20C506D2A	20	2	M10	94 mm	1,300 mm	100 mm	50 mm	6 mm	50 mm
EEB22C506D0A	22	0	M10	94 mm	1,250 mm	100 mm	50 mm	6 mm	50 mm
EEB22C506D1A	22	1	M10	94 mm	1,325 mm	100 mm	50 mm	6 mm	50 mm
EEB22C506D2A	22	2	M10	94 mm	1,400 mm	100 mm	50 mm	6 mm	50 mm
EEB24C506D0A	24	0	M10	94 mm	1,350 mm	100 mm	50 mm	6 mm	50 mm
EEB24C506D1A	24	1	M10	94 mm	1,425 mm	100 mm	50 mm	6 mm	50 mm
EEB24C506D2A	24	2	M10	94 mm	1,500 mm	100 mm	50 mm	6 mm	50 mm
EEB26C506D0A	26	0	M10	94 mm	1,500 mm	100 mm	50 mm	6 mm	50 mm
EEB26C506D1A	26	1	M10	94 mm	1,575 mm	100 mm	50 mm	6 mm	50 mm
EEB26C506D2A	26	2	M10	94 mm	1,650 mm	100 mm	50 mm	6 mm	50 mm

Part Number	Number of Connections	Number of Disconnects	Thread Size	Height	Length	Width 1	Width 2	Thickness	A
EEB28C506D0A	28	0	M10	94 mm	1,600 mm	100 mm	50 mm	6 mm	50 mm
EEB28C506D1A	28	1	M10	94 mm	1,675 mm	100 mm	50 mm	6 mm	50 mm
EEB28C506D2A	28	2	M10	94 mm	1,750 mm	100 mm	50 mm	6 mm	50 mm
EEB30C506D0A	30	0	M10	94 mm	1,700 mm	100 mm	50 mm	6 mm	50 mm
EEB30C506D1A	30	1	M10	94 mm	1,775 mm	100 mm	50 mm	6 mm	50 mm
EEB30C506D2A	30	2	M10	94 mm	1,850 mm	100 mm	50 mm	6 mm	50 mm
Finish: Tinned									
EEB04T506D0A	4	0	M10	94 mm	300 mm	100 mm	50 mm	6 mm	50 mm
EEB04T506D1A	4	1	M10	94 mm	375 mm	100 mm	50 mm	6 mm	50 mm
EEB04T506D2A	4	2	M10	94 mm	450 mm	100 mm	50 mm	6 mm	50 mm
EEB06T506D0A	6	0	M10	94 mm	400 mm	100 mm	50 mm	6 mm	50 mm
EEB06T506D1A	6	1	M10	94 mm	475 mm	100 mm	50 mm	6 mm	50 mm
EEB06T506D2A	6	2	M10	94 mm	550 mm	100 mm	50 mm	6 mm	50 mm
EEB08T506D0A	8	0	M10	94 mm	500 mm	100 mm	50 mm	6 mm	50 mm
EEB08T506D1A	8	1	M10	94 mm	575 mm	100 mm	50 mm	6 mm	50 mm
EEB08T506D2A	8	2	M10	94 mm	650 mm	100 mm	50 mm	6 mm	50 mm
EEB10T506D0A	10	0	M10	94 mm	600 mm	100 mm	50 mm	6 mm	50 mm
EEB10T506D1A	10	1	M10	94 mm	675 mm	100 mm	50 mm	6 mm	50 mm
EEB10T506D2A	10	2	M10	94 mm	750 mm	100 mm	50 mm	6 mm	50 mm
EEB12T506D0A	12	0	M10	94 mm	700 mm	100 mm	50 mm	6 mm	50 mm
EEB12T506D1A	12	1	M10	94 mm	775 mm	100 mm	50 mm	6 mm	50 mm
EEB12T506D2A	12	2	M10	94 mm	850 mm	100 mm	50 mm	6 mm	50 mm
EEB14T506D0A	14	0	M10	94 mm	850 mm	100 mm	50 mm	6 mm	50 mm
EEB14T506D1A	14	1	M10	94 mm	925 mm	100 mm	50 mm	6 mm	50 mm
EEB14T506D2A	14	2	M10	94 mm	1,000 mm	100 mm	50 mm	6 mm	50 mm
EEB16T506D0A	16	0	M10	94 mm	950 mm	100 mm	50 mm	6 mm	50 mm
EEB16T506D1A	16	1	M10	94 mm	1,025 mm	100 mm	50 mm	6 mm	50 mm
EEB16T506D2A	16	2	M10	94 mm	1,100 mm	100 mm	50 mm	6 mm	50 mm
EEB18T506D0A	18	0	M10	94 mm	1,050 mm	100 mm	50 mm	6 mm	50 mm
EEB18T506D1A	18	1	M10	94 mm	1,125 mm	100 mm	50 mm	6 mm	50 mm
EEB18T506D2A	18	2	M10	94 mm	1,200 mm	100 mm	50 mm	6 mm	50 mm
EEB20T506D0A	20	0	M10	94 mm	1,150 mm	100 mm	50 mm	6 mm	50 mm
EEB20T506D1A	20	1	M10	94 mm	1,225 mm	100 mm	50 mm	6 mm	50 mm
EEB20T506D2A	20	2	M10	94 mm	1,300 mm	100 mm	50 mm	6 mm	50 mm
EEB22T506D0A	22	0	M10	94 mm	1,250 mm	100 mm	50 mm	6 mm	50 mm
EEB22T506D1A	22	1	M10	94 mm	1,325 mm	100 mm	50 mm	6 mm	50 mm
EEB22T506D2A	22	2	M10	94 mm	1,400 mm	100 mm	50 mm	6 mm	50 mm
EEB24T506D0A	24	0	M10	94 mm	1,350 mm	100 mm	50 mm	6 mm	50 mm
EEB24T506D1A	24	1	M10	94 mm	1,425 mm	100 mm	50 mm	6 mm	50 mm
EEB24T506D2A	24	2	M10	94 mm	1,500 mm	100 mm	50 mm	6 mm	50 mm
EEB26T506D0A	26	0	M10	94 mm	1,500 mm	100 mm	50 mm	6 mm	50 mm
EEB26T506D1A	26	1	M10	94 mm	1,575 mm	100 mm	50 mm	6 mm	50 mm
EEB26T506D2A	26	2	M10	94 mm	1,650 mm	100 mm	50 mm	6 mm	50 mm
EEB28T506D0A	28	0	M10	94 mm	1,600 mm	100 mm	50 mm	6 mm	50 mm
EEB28T506D1A	28	1	M10	94 mm	1,675 mm	100 mm	50 mm	6 mm	50 mm
EEB28T506D2A	28	2	M10	94 mm	1,750 mm	100 mm	50 mm	6 mm	50 mm
EEB30T506D0A	30	0	M10	94 mm	1,700 mm	100 mm	50 mm	6 mm	50 mm
EEB30T506D1A	30	1	M10	94 mm	1,775 mm	100 mm	50 mm	6 mm	50 mm
EEB30T506D2A	30	2	M10	94 mm	1,850 mm	100 mm	50 mm	6 mm	50 mm

Tinned finish is 8 microns according to ASTM B545 Service Class "C" for corrosive environments.

DISCONNECTING LINK

FEATURE

- Allows for quick and easy disconnection of the earthing system to facilitate testing of the earth in isolation
- High conductivity, hard drawn, electrolytic tough pitch copper per EN 13601
- Includes halogen-free polyamide insulators, stainless steel (EN 1.4401) hardware and mounting brackets

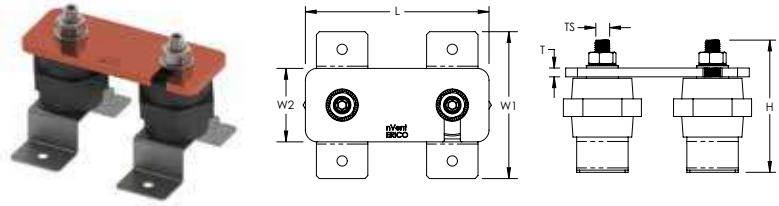

Material: Copper

Part Number	Finish	Thread Size	Height	Length	Width 1	Width 2	Thickness	Unit Weight
DLINKC	Bare	M10	90 mm	125 mm	100 mm	50 mm	6 mm	0.77 kg
DLINKT	Tinned	M10	90 mm	125 mm	100 mm	50 mm	6 mm	0.77 kg

Tinned finish is 8 microns according to ASTM B545 Service Class "C" for corrosive environments.

SWAN-NECK LINK

FEATURE

- Standalone link that joins two or more nVent ERICO electrical earth bars
- High conductivity, hard drawn, electrolytic tough pitch copper per EN 13601

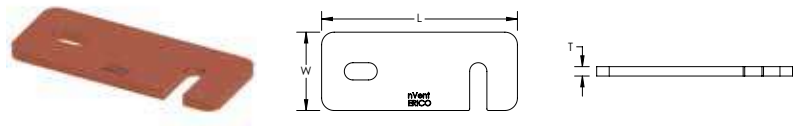

Material: Copper

Part Number	Finish	Length	Width	Thickness	Unit Weight
EEBDLC	Bare	125 mm	50 mm	6 mm	0.3 kg
EEBDLT	Tinned	125 mm	50 mm	6 mm	0.3 kg

Tinned finish is 8 microns according to ASTM B545 Service Class "C" for corrosive environments.

GROUNDING BUSBAR

FEATURE

- Provides a convenient, single-point grounding and bonding location
- Conductors are welded to the bar using a nVent ERICO Cadweld exothermic connection or are mechanically fastened by using lugs
- Custom bars can be designed and manufactured to customer specifications



Proper bonding is essential to create an equipotential plane between service grounds and equipment during fault and transient conditions. This equipotential plane provides a near-zero voltage differential, and serves to protect people and equipment during these events. The grounding busbar is the most popular bonding product in use today.

EGB-A-14-4-12-CC-T-1T-K

EGB nVent ERICO Grounding Busbar Designation

A	Configuration	A = Busbar, Insulators and Brackets B = Busbar and Brackets C = Busbar Only D = Busbar and Insulators
14	Thickness (")	18: 1/8" · 14: 1/4" · 38: 3/8" · 12: 1/2" · 58: 5/8" · 34: 3/4"
4	Width (")	
12	Length (")	Rounded to the nearest inch, 144" max
CC	Hole Pattern	Diagrams are representative of the hole pattern. The number of holes is dependent on the length of the grounding busbar.
T*	Tin Plating	
1T*	nVent ERICO Cable Code	1K: #4 Sol Tin · 1T: #2 Sol Tin 2C: 1/0 · 2G: 2/0 · 2L: 3/0 · 2Q: 4/0 2V: 250 kcmil · 3D: 350 kcmil · 3Q: 500 kcmil · 4L: 750 kcmil
K*	Pigtail Length (')	A:1 · B:2 · C:3 · D:4 · E:5 · F:6 · G:7 · H:8 · J:9 · K:10 · L:12 · M:14 · N:16 P:18 · Q:20 · R:22 · S:24 · T:26 · U:28 · V:30 · W:32 · X:34 · Y:36 · Z:38

Material: Copper



Part Number	Article Number	Hole Pattern	Mounting Hole Size	Length	Width	Thickness	Tin Plating	Pigtail Included	Certifications
Busbar Configuration: Busbar and Brackets									
EGBB14212JJ	-	JJ	11.1 mm	305 mm	51 mm	6.4 mm	No	No	cULus
Busbar Configuration: Busbar and Insulators									
EGBD14224BB	-	BB	11.1 mm	610 mm	51 mm	6.4 mm	No	No	cULus
Busbar Configuration: Busbar Only									
EGBC14212NN	-	NN	11.1 mm	305 mm	51 mm	6.4 mm	No	No	cULus
EGBC14412LLT	-	LL	11.1 mm	305 mm	102 mm	6.4 mm	Yes	No	cULus
Busbar Configuration: Busbar, Insulators and Brackets									
EGBA14412CC	-	CC	11.1 mm	305 mm	102 mm	6.4 mm	No	No	cULus
EGBA14436CC	-	CC	11.1 mm	914 mm	102 mm	6.4 mm	No	No	cULus
EGBA14612AA	-	AA	11.1 mm	305 mm	152 mm	6.4 mm	No	No	cULus
EGBA14416AAT	-	AA	11.1 mm	406 mm	102 mm	6.4 mm	Yes	No	cULus
EGBA14618AA	-	AA	11.1 mm	457 mm	152 mm	6.4 mm	No	No	cULus
EGBA14212BBT	-	BB	11.1 mm	305 mm	51 mm	6.4 mm	Yes	No	cULus
EGBA14424DDT	-	DD	11.1 mm	610 mm	102 mm	6.4 mm	Yes	No	cULus
EGBA14220DGT	-	DG	11.1 mm	508 mm	51 mm	6.4 mm	Yes	No	cULus
EGBA14206EET	-	EE	11.1 mm	152 mm	51 mm	6.4 mm	Yes	No	cULus
EGBA14212EET	-	EE	11.1 mm	305 mm	51 mm	6.4 mm	Yes	No	cULus
EGBA14215EET	-	EE	11.1 mm	381 mm	51 mm	6.4 mm	Yes	No	cULus
EGBA14224EET	-	EE	11.1 mm	610 mm	51 mm	6.4 mm	Yes	No	cULus
EGBA14240EET	-	EE	11.1 mm	1,016 mm	51 mm	6.4 mm	Yes	No	cULus
EGBA14224GGT	-	GG	11.1 mm	610 mm	51 mm	6.4 mm	Yes	No	cULus

Part Number	Article Number	Hole Pattern	Mounting Hole Size	Length	Width	Thickness	Tin Plating	Pigtail Included	Certifications
EGBA14212HH	-	HH	11.1 mm	305 mm	51 mm	6.4 mm	No	No	cULus
EGBA14216HH	-	HH	11.1 mm	406 mm	51 mm	6.4 mm	No	No	cULus
EGBA14420HIG	-	HIG	11.1 mm	508 mm	102 mm	6.4 mm	No	No	cULus
EGBA14215JJ	-	JJ	11.1 mm	381 mm	51 mm	6.4 mm	No	No	cULus
EGBA14420LL	-	LL	11.1 mm	508 mm	102 mm	6.4 mm	No	No	cULus
EGBA14412MM	-	MM	11.1 mm	305 mm	102 mm	6.4 mm	No	No	cULus
EGBA14424MM	-	MM	11.1 mm	610 mm	102 mm	6.4 mm	No	No	cULus
EGBA14212TES	-	TES	11.1 mm	305 mm	51 mm	6.4 mm	No	No	cULus
EGBA14215TES	-	TES	11.1 mm	381 mm	51 mm	6.4 mm	No	No	cULus

Busbar Configuration: Busbar, Insulators, Brackets and Fasteners

SEB-06	545010	EE	11.1 mm	400 mm	50 mm	5.0 mm	No	No	
545020	545020	EE	11.1 mm	475 mm	50 mm	5.0 mm	No	No	
SEB08	-	EE	11.1 mm	500 mm	50 mm	5.0 mm	No	No	
SEB-10	545030	EE	11.1 mm	600 mm	50 mm	5.0 mm	No	No	

Diagrams are representative of the hole pattern. The number of holes is dependent on the length of the grounding busbar. Additional configurations are available by special order. Note special orders may incur additional lead time.

TELECOM GROUNDING BUSBAR

FEATURE

- Meets TIA-607-C and conforms to BICSI® recommendations
- Complies with NEMA® standards
- Accepts two hole lugs with 5/16" or 7/16" bolt holes (hardware not included)
- Telecom grounding busbar splice kits are available to extend the length of the busbar

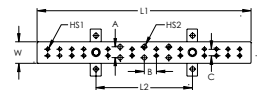

Material: Copper
 Width: 50.8 mm
 Thickness: 6.35 mm



Part Number	Length 1	Length 2	Hole Size 1	Hole Size 1 Number of Pairs	Hole Size 2	Hole Size 2 Number of Pairs	A	B	C
Tin Plating: No									
TGBA12L06P	305 mm	229 mm	8 mm	6	11 mm	3	25.4 mm	28.6 mm	15.9 mm
TGBA24L14P	610 mm	457 mm	8 mm	14	11 mm	5	25.4 mm	28.6 mm	15.9 mm
Tin Plating: Yes									
TGBA12L06PT	305 mm	229 mm	8 mm	6	11 mm	3	25.4 mm	28.6 mm	15.9 mm
TGBA20L12PT	508 mm	229 mm	8 mm	12	11 mm	3	25.4 mm	28.6 mm	15.9 mm
TGBA24L14PT	610 mm	457 mm	8 mm	14	11 mm	5	25.4 mm	28.6 mm	15.9 mm
TGBA29L18PT	737 mm	457 mm	8 mm	18	11 mm	5	25.4 mm	28.6 mm	15.9 mm

TELECOM MAIN GROUNDING BUSBAR

FEATURE

- Meets TIA-607-C and conforms to BICSI® recommendations
- Complies with NEMA® standards
- Accepts two hole lugs with 5/16" or 7/16" bolt holes (hardware not included)
- Telecom grounding busbar splice kits are available to extend the length of the busbar

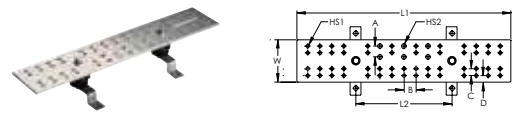

Material: Copper
 Width: 101.6 mm
 Thickness: 6.35 mm



Part Number	Length 1	Length 2	Hole Size 1	Hole Size 1 Number of Pairs	Hole Size 2	Hole Size 2 Number of Pairs	A	B	C
Tin Plating: No									
TMGBA12L15P	305 mm	229 mm	5/16"	15	7/16"	3	25.4 mm	28.6 mm	15.9 mm
TMGBA20L27P	508 mm	229 mm	5/16"	27	7/16"	3	25.4 mm	28.6 mm	15.9 mm
Tin Plating: Yes									
TMGBA12L15PT	305 mm	229 mm	5/16"	15	7/16"	3	25.4 mm	28.6 mm	15.9 mm
TMGBA24L33PT	610 mm	457 mm	5/16"	33	7/16"	5	25.4 mm	28.6 mm	15.9 mm
TMGBA29L41PT	737 mm	457 mm	5/16"	41	7/16"	5	25.4 mm	28.6 mm	15.9 mm

PERIMETER GROUNDING BUSBAR FOR CORNERS

FEATURE

- For use in installing perimeter grounding busbar system to fit within or around 90° corners

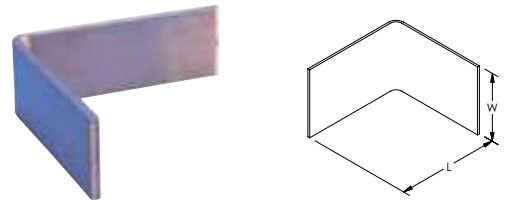

Material: Copper



Part Number	Length	Width	Thickness
EPGC1426X6	152.4 mm	50.8 mm	6.4 mm

PERIMETER GROUNDING BUSBAR FOR WALLS

FEATURE

- Perimeter grounding busbars are used to terminate ground wires and cables from equipment and other devices
- For busbars that include insulators and brackets, eight individual brackets and insulators are provided

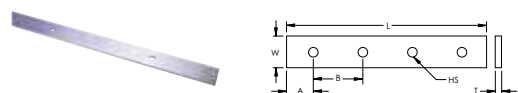

Material: Copper
 Busbar Configuration: Busbar Only



Part Number	Length	Width	Thickness	A	B	Hole Size
EPGC142144	3.66 m	50.8 mm	6.4 mm	381 mm	762 mm	11.11 mm

GROUNDING BUSBAR MOUNTING KIT

FEATURE

- Includes hardware, fasteners, insulators and brackets

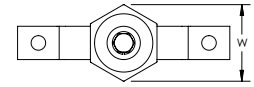
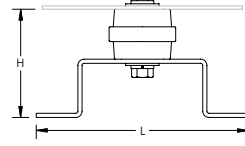

Part Number	Busbar Width	Height	Length	Width
Material: Stainless Steel 304 (EN 1.4301), Polyamide – Finish: Bare				
B548A41	25 – 51 mm	67 mm	108 mm	51 mm
Material: Steel, Polyamide – Finish: Electrogalvanized				
FEB35M10	100 mm	59 mm	100 mm	51 mm

GROUNDING BUSBAR MOUNTING KIT WITH BEAM CLAMP

FEATURE

- Mounting kit for grounding busbars to steel beam
- Includes stainless steel hardware, fasteners, insulators and brackets

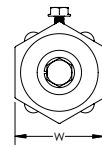
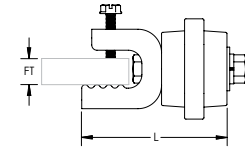

Material: Polyamide, Stainless Steel 304 (EN 1.4301)

Part Number	Flange Thickness	Length	Width
B548A39	22.2 mm Max	85.7 mm	50.4 mm

THEFT-DETERRENT GROUNDING BUSBAR, FLANGE MOUNT ASSEMBLY

FEATURE

- Mounts to a typical structural beam flange on a telecom tower without cutting or drilling the flange
- Accepts standard telecommunication grounding lugs (lugs not included)
- Includes 14 Standard Spacers (TDSGAS)

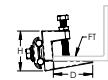
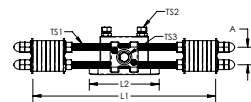

Material: Copper, Stainless Steel 18-8 (EN 1.4305), Nylon
 Finish: Tinned
 Spacer Thickness: 6.4 mm



Part Number	Length 1	Length 2	Depth	Height	A	Flange Thickness	Thread Size 1	Thread Size 2	Thread Size 3
TDSGABC14	266 mm	101.6 mm	54.1 mm	69 mm	25.4 mm	6.4 – 25.4 mm	3/8 UNC	5/16 UNC	5/16 UNC

THEFT-DETERRENT GROUNDING BUSBAR, POST MOUNT ASSEMBLY

FEATURE

- Mounts to a Schedule 40 pipe or post without cutting or drilling the pipe
- Accepts standard telecommunication grounding lugs (lugs not included)
- Includes 14 Standard Spacers (TDSGAS)

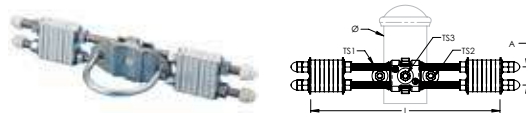

Material: Copper, Stainless Steel 304 (EN 1.4301), Stainless Steel 18-8 (EN 1.4305)
 Finish: Tinned
 Spacer Thickness: 6.4 mm



Part Number	Length	A	Fence Post Size, Nominal	Fence Post Outside Diameter, Actual	Thread Size 1	Thread Size 2	Thread Size 3
TDSGAPC14	266 mm	25.4 mm	1 1/2" - 2"	48.0 - 63.5 mm	3/8 UNC	5/16 UNC	5/16 UNC

THEFT-DETERRENT GROUNDING BUSBAR, WALL MOUNT ASSEMBLY

FEATURE

- Utilizes a utility or telecom tower's or other mounting structure's connection to a ground ring to provide equipotential bonding and a low-impedance path to ground
- Can be used for any mounting application and in any configuration
- Accepts standard telecommunication grounding lugs (lugs not included)
- Includes 17 Standard Spacers (TDSGAS)

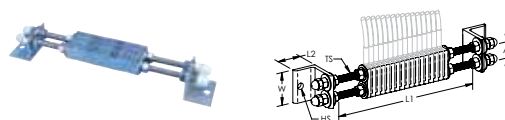

Material: Copper, Aluminum, Stainless Steel 304 (EN 1.4301)
 Finish: Tinned
 Spacer Thickness: 6.4 mm



Part Number	Length 1	Length 2	Width	Height	A	Hole Size	Thread Size
TDSGAWB17	235 mm	38.1 mm	50.8 mm	50.8 mm	25.4 mm	9.8 mm	3/8 UNC

EARTH BLOCK

FEATURE

- Used to connect multiple earthing cables to a single point which then connects to the earthing system
- Two holes available (countersink M5) for installation of the earth block

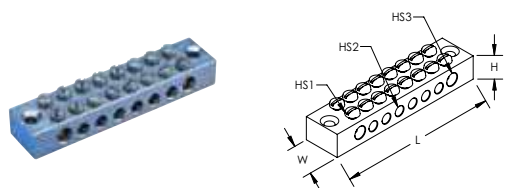

Material: Brass
 Finish: Tinned

Part Number	Article Number	Length	Width	Height	Hole Size 1	Hole Size 2	Hole Size 3
EBL08	711470	88 mm	20 mm	13 mm	4 mm	5.2 mm	6.5 mm

INTERSYSTEM BONDING TERMINATION BAR

FEATURE

- Interconnects and terminates grounding conductors from telephone, CATV, radio and TV antennas
- Ideal for residential and small commercial applications
- Meets requirements of 2008 NEC® Article 250.94
- Accommodates five connectors for conductor sizes #14 Solid – #6 Stranded (1,5 – 25 mm²)
- Accommodates one connector for conductor sizes #6 Solid – #2 Stranded (16 – 35 mm²)
- Integral mounting base enables easy installation
- Includes mounting hardware
- Connects to grounding electrode conductor – does not rely on meter base enclosure bonding connection

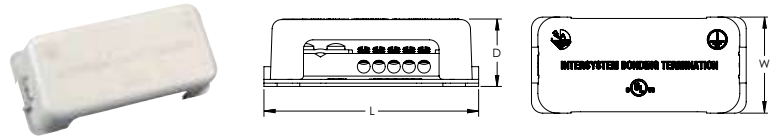

The Intersystem Bonding Termination (IBTB), part of the nVent ERICO line of Facility Electrical Protection products, is designed to meet the requirements of the 2008 NEC® Article 250.94 "Bonding for Other Systems." The IBTB is mounted adjacent to the meter base or service entrance equipment and is a convenient way to interconnect and terminate grounding conductors from telephone, CATV or radio and television antennas. The IBTB includes corrosion-resistant, stainless steel mounting hardware and is easily accessible for connection and inspection. The lay-in connection clamp (#6- #2 AWG, or 16-35 mm²) allows easy installation of the grounding electrode conductor in one continuous length, where possible. The polymeric base and housing is impact-resistant, UVstabilized and meets UL® requirements for weatherability performance.



Part Number	Depth	Length	Width
IBTB	36 mm	102 mm	51 mm

Grounding Tools

GROUND ROD DRIVER

FEATURE

- Usable on all types of round ground rods: copper-bonded, galvanized, and stainless steel
- Inserts are interchangeable with standard ground rod driver body
- The driver will not deform the end of the rod, making connection of the ground conductor quick and easy



Part Number	Article Number	Ground Rod Diameter, Nominal	Ground Rod Diameter, Actual	Length	Unit Weight
EGRD34	158520	3/4" Max	17.2 mm Max	1,500 mm	10.4 kg
EGRD58	158500	5/8" Max	14.2 mm Max	1,500 mm	10.4 kg

GROUND ROD DRIVER REPLACEMENT INSERT

FEATURE

- For use with the EGRD Ground Rod Driver
- Inserts are interchangeable with standard ground rod driver body



Part Number	Article Number	Ground Rod Diameter, Nominal	Ground Rod Diameter, Actual	Unit Weight
EGRD34I	158530	3/4"	17.2 mm Max	2.7 kg
EGRD58I	158510	5/8"	14.2 mm Max	2.7 kg

GROUND ROD DRIVING HEAD FOR POWER TOOLS

FEATURE

- For use in power-assisted ground rod drivers



Material: Steel
Ground Rod Type: Copper-bonded, Galvanized

Part Number	Ground Rod Diameter, Nominal	Diameter 1	Diameter 2	Length
DH58	5/8"	14.7 mm	21.6 mm	178 mm
DH34	3/4"	19.8 mm	21.6 mm	178 mm

GROUND ROD DRIVING HEAD FOR ROTARY HAMMER

FEATURE

- Ground rod driving head for use with a rotary hammer

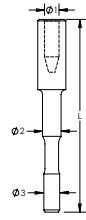

Material: Steel
Ground Rod Type: Copper-bonded, Galvanized

Part Number	Ground Rod Diameter, Nominal	Diameter 1	Diameter 2	Diameter 3	Length
B13716RH15	5/8"	14.7 mm	18.8 mm	16.3 mm	196 mm

GROUND ROD DRIVE SLEEVE FOR POINTED GROUND RODS

FEATURE

- For use with unthreaded ground rods
- Slides on top of ground rod to prevent mushrooming while driving into ground

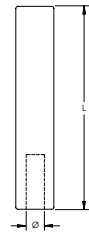
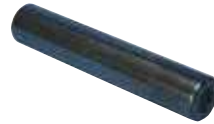

Material: Steel
Ground Rod Type: Copper-bonded, Galvanized

Part Number	Ground Rod Diameter, Nominal	Diameter	Length
DH12M	1/2"	13.5 mm	100 mm
DH58M	5/8"	16.0 mm	100 mm
DH34M	3/4"	20.0 mm	100 mm
B13722	1"	23.9 mm	152 mm

2-, 3- AND 4-POINT GROUND RESISTANCE TESTER KIT

FEATURE

- Measures ground resistance (2- and 3-Point) Fall-of-Potential method and soil resistivity (4-Point)
- Fuse protection of 0.1A, >250V, 0.25 x 1.25" with 30kA Interrupt Capacity
- Both models will perform over 2,000 measurements of the 15-second tests between recharging or battery replacement
- Provides a response time of approximately four to eight seconds for a stabilized measurement
- Step voltage tests and touch potential measurements
- Auto-ranging: automatically selects the optimum resistance range and test current
- Designed to reject high levels of noise and interference
- Extremely simple to operate: connect – press – hold – read
- May also be used for continuity tests on bonding
- Large easy-to-read backlit display
- LED on faceplate informs operator of high input noise, high auxiliary rod resistance and fault connections
- Rugged dustproof and rainproof field case
- Color-coded terminals
- Low battery indication



Part Number	Measurement Range	Resolution	Open Voltage	Test Current	Operating Frequency	Accuracy	Auxiliary Electrode Influence	Withstanding Voltage	Power Source
EST4620	0 – 2,000 Ω	10 m Ω – 1 Ω	42 V Max	10.0 – 0.1 mA	128 Hz square wave	2% of Reading +/- 1ct, 5% of Reading +/- 3ct	3 – 50 k Ω	250 VAC, 100 VDC	Battery-powered, with eight C cell batteries included
EST4630	0 – 2,000 Ω	10 m Ω – 1 Ω	42 V Max	10.0 – 0.1 mA	128 Hz square wave	2% of Reading +/- 1ct, 5% of Reading +/- 3ct	3 – 50 k Ω	250 VAC, 100 VDC	AC-powered with rechargeable NiMH battery pack

Kit includes: Two 300' (91.4 m) color-coded leads on spools (red and blue), two 5' (1.5 m) color-coded leads (red and blue), two 100' (30.5 m) color-coded leads (green and black), four 14.5" (368 mm) T-shaped auxiliary ground electrodes, one set of five-spaded lugs, one 100' (30.5 m) tape measure, and one carrying bag.

2-, 3- AND 4-POINT GROUND RESISTANCE TESTER KIT WITH DATAVIEW® SOFTWARE

FEATURE

- Measures Ground Impedance at frequencies up to 5kHz to test lightning strike protection
- Ground Resistance testing using the 2 clamp method (no auxiliary rods needed) using optional current probes
- Includes DataView® software for data storage, real-time display, analysis, report generation and system configuration
- 3-Point Fall-of-Potential measurement with manual or automatic frequency selection
- Used under difficult conditions such as the presence of high-stray currents that normally affect accuracy
- Automatic report generation including the fall of potential plot
- 4-Point soil resistivity measurement with automatic calculation of Rho and user selection of Wenner or Schlumberger test method
- 3-Point earth coupling measurement
- Manual and automatic frequency scan from 41 to 5,078Hz for optimum test accuracy in electrically-noisy environments
- Selectable test voltage of 16 or 32V up to 250mA of test current
- 2- and 4-Wire Bond Resistance/Continuity Measurement (DC Resistance) with automatic polarity reversal
- Stores up to 512 complete test results in internal memory
- Optically isolated USB communication included
- Display with automatic backlight when entering a function
- Rugged dustproof and rainproof field case - IP53 rated in closed position
- AC-powered with rechargeable NiMH batteries from wall charger or vehicle power
- Auto-off power management



Part Number

EST6472

Ground Resistance Tester Information					
3-Point Measurement					
Range (Auto-Ranging)	Resolution	Test Voltage	Operating Frequency	Test Current	Accuracy
0.09Ω to 99.9kΩ	0.01Ω to 100Ω	Nominal 16 or 32Vrms user selectable	41 to 5078Hz automatic or user selectable	Up to 250mA	±2% of Reading + 1ct @ 128Hz
2-Clamp Measurement					
Range	Resolution	Operating Frequency			
0.1 to 500Ω	0.01 to 1Ω	Auto: 1367Hz; Manual: 128Hz-1367Hz-1611Hz-1758Hz			
Soil Resistivity 4-Point Measurement					
Test Method	Range (Auto-Ranging)	Resolution	Test Voltage	Operating Frequency	
Wenner or Schlumberger selectable with automatic calculation of test results in Ω-meters	0.01 to 99.99kΩ; ρ max: 999kΩm	0.01 to 100Ω	16 or 32V user selectable	From 41 to 128Hz selectable	
External Voltage Measurement					
Range (Auto-Ranging)	Accuracy				
0.1 to 65.0VAC/DC – DC to 440Hz	±2% of Reading + 1ct				
Resistance Measurement (Bond Testing)					
Measurement Type	Range (Auto-Ranging)	Accuracy	Test Voltage	Test Current	
2-Pole (with lead resistance compensation) or 4-Pole (Kelvin sensing) user selectable	2-Pole 0.02Ω to 99.99kΩ; 4-Pole 0.02Ω to 99.99kΩ	±2% of Reading + 2cts	16VDC (+, - or auto polarity)	Up to 250mA max	
Data Storage					
Memory Capacity					
512 test results (64KB)					
Power					
Power Source	Recharging Source				
9.6V rechargeable battery pack (included)	110/220 50/60Hz external charger with 18Vdc, 1.9A output				

Kit includes: Two 300' (91.4 m) color-coded leads on spools (red and blue), two 5' (1.5 m) color-coded leads (red and blue), two 100' (30.5 m) color-coded leads (green and black), four 14.5" (368 mm) T-shaped auxiliary ground electrodes, one set of five-spaded lugs, one 100' (30.5 m) tape measure, and one carrying bag. Ground Resistance Tester Clamp-On Probe is not included and must be ordered separately.

HANDHELD CLAMP-ON GROUND RESISTANCE TESTER

FEATURE

- Measures earth resistance without need to disconnect from the electrical system or need for auxillary ground electrodes or reels
- Ground Resistance is auto-ranging from 1 to 199Ω
- Current Measurement is auto-ranging from 1mA to 40A
- Ground voltage indication - warns of unsafe conditions
- Clamping diameter of 1.4" (35 mm) with large jaw design
- Stores up to 300 measurements
- Includes a hard carrying case, calibration loop, four 1.5V AA batteries and a user manual



Part Number	Article Number	Ground Resistance Measurement Range	Ground Resistance Resolution	Ground Resistance Accuracy	Current Measurement Range	Current Measurement Resolution	Current Measurement Accuracy	Current Measurement Frequency	Operating Frequency	Loop Impedance Measurement
EST401	702390	0.01 – 1,500.00 Ω	0.001 – 50.000 Ω	Approx. 1.5% - 25%	0.20 mA – 39.99 A	1 μA – 10 mA	+/- 2%	47 – 800 Hz	2,083 Hz	10 to 100μH; 100 to 500μH

GROUND RESISTANCE TESTER CLAMP-ON PROBE

FEATURE

- AC Clamp-on probe for use with EST6472
- Extends use of EST6472 to be used as a clamp-on ground resistance tester



Part Number	Unit Weight
ESR182	1.36 kg

GROUND RESISTANCE TESTER CABLE REEL

FEATURE

- Includes two reels of silicone rubber insulated wire—one reel is red and the other reel is blue—for easy stake identification
- The far end of test lead remains attached to the reel base, which eliminates tangling and speeds up the process of test stake deployment
- Each reel includes 500' (152.4 m) of cable, a screwdriver and a lead that connects the reel to the test meter



Part Number	Article Number	Cable Length	Unit Weight
ESTREELKIT500	702350	152.4 m	7.7 kg

nVent ERICO Cadweld Molds

HOW TO ORDER NVENT ERICO CADWELD PRODUCTS

This catalog lists the most popular nVent ERICO Cadweld connections using solid or concentric stranded copper conductor, insulated or bare. Look in the index for the connection you need. To save time and money, avoid non-catalog items or specials whenever possible.

If you cannot find the connection you need, contact nVent ERICO or your local distributor or agent. We have designed over 45,000 connections, and “specials” are designed every day.

1. What connection do you want?

We strongly recommend that wherever possible you use molds listed in this catalog. After selecting the connection, turn to the appropriate page and select the mold, weld metal and tools you need.

2. Only the most popular Cadweld connections are listed in this catalog.

For a complete listing of Cadweld Exolon connections, please refer to nVent.com/ERICO or your local nVent ERICO representative.

3. What are the conductor sizes?

This catalog covers connections between solid or concentric stranded copper conductors to each other, to lugs, to ground rods, to rebar, to rail and to special grounding accessories. For sizes not listed, contact your local Cadweld distributor, agent, or nVent ERICO.

Note: Other publications describe connections to conductors of copperclad, high voltage copper, aluminum, busbar, lightning protection cable, steel cable, etc.

4. You must have the following to make a weld:

- 4.1 Mold to fit your conductors
- 4.2 Weld metal required by your mold
- 4.3 Handle clamps on frame
- 4.4 Flint ignitor (included with handle clamps and frames)
- 4.5 If using Cadweld Exolon, you need a Relia-Start™ battery instead of a flint ignitor.
- 4.6 Lugs, sleeves, packing material listed on the page with the mold.

OTHER INFORMATION

Certain tools may be required for various connections. If required, these tools are listed on the same pages as the connection and in Section A. Some tools in section A can save you a lot of time. Also refer to A9E, Contractor Tips, to make your job easier, and learn about labor saving ideas.

For complete pricing information, please visit nVent.nVent.com/ERICO or contact an nVent ERICO Representative

For Cadweld literature, guides, instructional videos, and more, visit nVent.com/ERICO.

For all your connection needs – we're only a phone call away.

Phone: 800-677-9089

Fax: 800-677-8131

or call your local Cadweld distributor, agent, or Cadweld regional sales manager

Required tools summary:

Required tools are listed with each mold. For your reference, handle clamps and/or frame are summarized below.

Mold	Required
A*	Includes frame with handle
C, Q & R	Requires L160
D, F & Z	Requires L159
E*	Includes frame but also requires L160
J*	Includes frame but also requires L159
K*, M* & V*	Includes frame with handles

* To order mold only – without handles or frame – add suffix "M" to mold part number.

Heavy Duty Electrical Connections for Stranded Concentric Copper Conductors

Heavy Duty connections were developed to be used on reclaimed cable. Heavy Duty connections use a larger size connection cavity in the mold and a larger size weld metal than the equivalent standard connections.

The larger size weld metal supplies extra BTU's (but not a higher temperature) to melt the heavy oxide coating on the conductor and to overcome severe field conditions.

Heavy Duty connections offer the following advantages:

- Eliminates cutting the run conductor on certain types of connections.
- Reduces cable cleaning requirements for old or reclaimed cable.
- Increases reliability under adverse field conditions.

CADWELD CONNECTIONS USED FOR GROUNDING REINFORCING BARS

Cadweld provides efficient and permanent connections for both grounding and attaching lightning protection conductors to rebar. When making Cadweld connections to rebar, the normal materials required are: mold, handle and weld metal. In addition, packing material is also required. These materials act as a seal between the mold and rebar to prevent leaks. One unit of packing material must be ordered for each weld.

CADWELD CONNECTIONS TO STRUCTURAL REINFORCING BAR AND ANCHOR BOLTS

Welding of ground conductors to reinforcing bars (rebar) by the Cadweld process should not be harmful if stresses in the rebar are below yield. As design stresses are normally only about 50% to 60% of the nominal yield strength of the rebar, welding by the Cadweld process should not be detrimental under design stresses.

As the ACI Building Code (ACI318-14 Commentary, 25.5.2.1) advises, "splice requirements encourage splicing bars at points of minimum stress ... encourage the location of splices away from regions of high tensile stress." The same advice should apply to locations of Cadweld connections of a ground conductor to rebar. Where possible, locate the weld area away from areas of maximum tensile stress, e.g., near the free end of the bar in a lap splice, on the hook extension for a hooked bar, etc. The same considerations apply to Cadweld connections to anchor bolts.

NOTE:

For lightning protection applications where the main lightning protection conductor is connected to the rebar, nVent ERICO recommends a 2/0 AWG copper conductor for structures over 75 feet in height and a #2 AWG copper conductor for structures under 75 feet. For a bonding conductor, a #6 AWG copper may be used. These sizes meet NFPA78 Code requirement. Anchor bolts are connected in the same way.

All welds to rebar requiring larger than a #150 weld metal will be sold only after review by nVent ERICO.

GROUNDING CONNECTION SPECIFICATION

This specification covers the Cadweld exothermic welding system for use in making electrical connections. The Cadweld system supplied under this specification shall include welding material, molds, tools and accessories as required.

Unless otherwise specified, Cadweld exothermic welding system shall be used for all electrical grounding connections of copper to copper and copper to steel conductors. Cadweld connections shall be suitable for exposure to the elements of direct burial in earth or concrete without degradation over the lifetime of the grounding system.

The Cadweld exothermic welding system furnished under this specification shall meet the applicable requirements of IEEE Standard 80 "IEEE Guide for Safety in AC Substation Grounding" and IEEE Standard 837 IEEE "Standard for Qualifying Permanent Connections Used in Substation Grounding". Independent test data showing conformance to IEEE Std. 837 shall be readily available.

The Cadweld Mold Numbering System

The Cadweld mold part number gives, in code, the complete information about the mold.
Type of connection, mold price key, and conductor size(s)

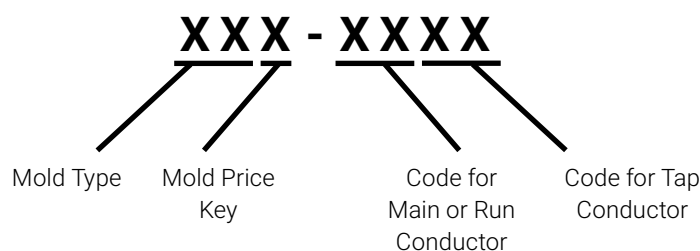

Examples:

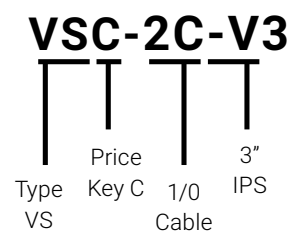
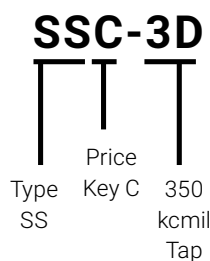
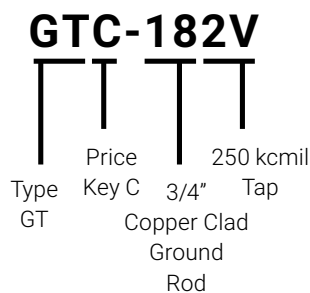
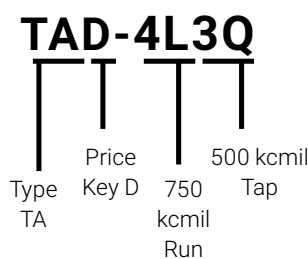

A graphite mold is used for making most Cadweld connections. Cadweld molds will generally last an average of 50 or more connections under normal usage.

PRICE KEY AND HANDLE CLAMP AND/OR FRAMES

Handle clamps are required for most molds. Specialized frames with handles are used on some molds. Flint igniters are included with handle clamps. The following handle clamps are most widely used.

L160 for all molds having a "C", "E", "R" and "Q" mold price key (3" wide molds)

L159 for all molds having a "D", "F", "J" and "Z" mold price key (4" wide molds)

Handle Clamps with an "XL" prefix are for use with the Cadweld Exolon system and do not come with a flint igniter. Mini E-Z Change Clamps for use with mini-welders.

Pictured below are the molds and handle clamps / and or frames and handles for the various price key molds:



"A" Price Key Mold
Includes Hold Down Frame



"C", "D", "F", "R", "Q" and "Z" Price Key Mold L160 or L159
Handle Clamp Required



"E" and "J" Price Key Mold
L160 or L159 Handle Clamp
Required



"M" and "V" Price Key Mold
Includes Frame with Handles



"H" Price Key Mold
Includes Hold Down Frame
with Handles



"G", "K", and "L" Price Key
Mold Includes Frame with Handles



"T", "P" and "N" Price Key Mold
Includes Mini-EZ Handle Clamp
To order mold only, add an "M"
suffix to the part number
(for example, SST1TM)

MOLD OPTIONS



SPLIT CRUCIBLE MOLDS

Molds made with a horizontal opening and solid crucible section may be specified as a split crucible type. The advantage of the split crucible mold is easier cleaning.

To order a mold with a split crucible, add an "L" suffix to the mold part number (for example, TAC2G2GL).



WEAR PLATES

Wear Plates reduce mechanical abrasion of molds at cable entry points and help prevent leakage of molten metal (particularly on larger 7 strand conductor). These features prolong mold life.

To order a mold with wear plates, add a "W" suffix to the mold part number (for example, PTC2G2GW).

CADWELD EXOLON

CADWELD EXOLON REDUCED-EMISSION MOLDS

Developed in 1988, Cadweld Exolon connections represented a significant advancement in welded electrical connections for sensitive indoor applications like data centers, hospitals, and other clean room environments. The virtual elimination of smoke and a unique electronic starting system makes this an ideal solution for sensitive applications. Each Cadweld Exolon package contains ceramic filters that produce an extremely low emission connection.



How to order CADWELD EXOLON:

1. To order Cadweld Exolon products, just specify molds and weld metal from the catalog and add an "XL" prefix.

Example: TAC2Q2Q becomes XLTAC2Q2Q, and 150 becomes XL150.

2. If the weld metal shown in the catalog shows more than one tube required such as 2-#200, you must specify #XL400 to get the correct size filters.

Example: XLTAD-4L3Q: XL400

3. The following molds require a price key change:

- "C" price key molds using 2-#150 weld metals change to XLD price key.
- "E" price key molds using 2-#150 weld metals change to XLJ price key.
- "H" price key molds using 2-#150 weld metals, contact ERICO.
- "M" price key molds using 2-#150 weld metals change to XLV price key.
- "R" price key molds using 2-#150 weld metals change to XLF price key.
- "T" price key molds, ALL change to XLP price key.

Example: TAC3Q3Q using 2-#150 weld metals change to XLTAD3Q3Q using #XL300 weld metal

4. Filters and ignitors are included with the weld metal. XL filters and ignitors are not sold separately.
5. The ignitor can be used only once and then must be discarded. Filters will last as specified in the instructions supplied with each mold.
6. A Relia-Start electric starter, part number XLB971A1 (battery, charger, carrying case and connecting cable), is required for XL weld metal. There is no starting material in the XL weld metal tube. Batteries operate about 200 starts before recharging from 120 VAC is required. The charger, all electrical connections and instructions are included in the battery case.
7. Baffle with cover is required for larger molds. Estimated life of the baffle is 500 welds.
 - XLB972A1 Baffle is required for molds using XL200 and XL250 weld metals.
 - XLB973A1 Baffle is required for molds using XL300 to XL750 weld metals.
8. For EZ Change Handles, add XL prefix. (Flint ignitor not included.)
9. Welding Tray, part number XLB974B2, is used under the mold to protect cables and equipment from hot materials.

CABLE TO CABLE



- Forms a permanent, low resistance connection
- Provides a molecular bond
- nVent ERICO Cadweld Exothermic Connections are rated with the same current capacity as the conductor
- Portable installation equipment with no external source of power required
- Installers can be easily trained to make nVent ERICO Cadweld Exothermic Connections
- Connections can be visually inspected

nVent ERICO Cadweld graphite molds are designed and engineered for thousands of connection styles and conductor combinations.

XX-X-XX-XX-L-M-W

XX	Mold Family	
X	Price Key	
XX	Conductor Code 1	
XX	Conductor Code 2	
L*	Split Crucible	Crucible section is split on molds designed with horizontal opening for easier cleaning
M*	Mold Only	
W*	Wear Plates	Reduce mechanical abrasion of molds at cable entry points

* Empty if none

MOLD FAMILY

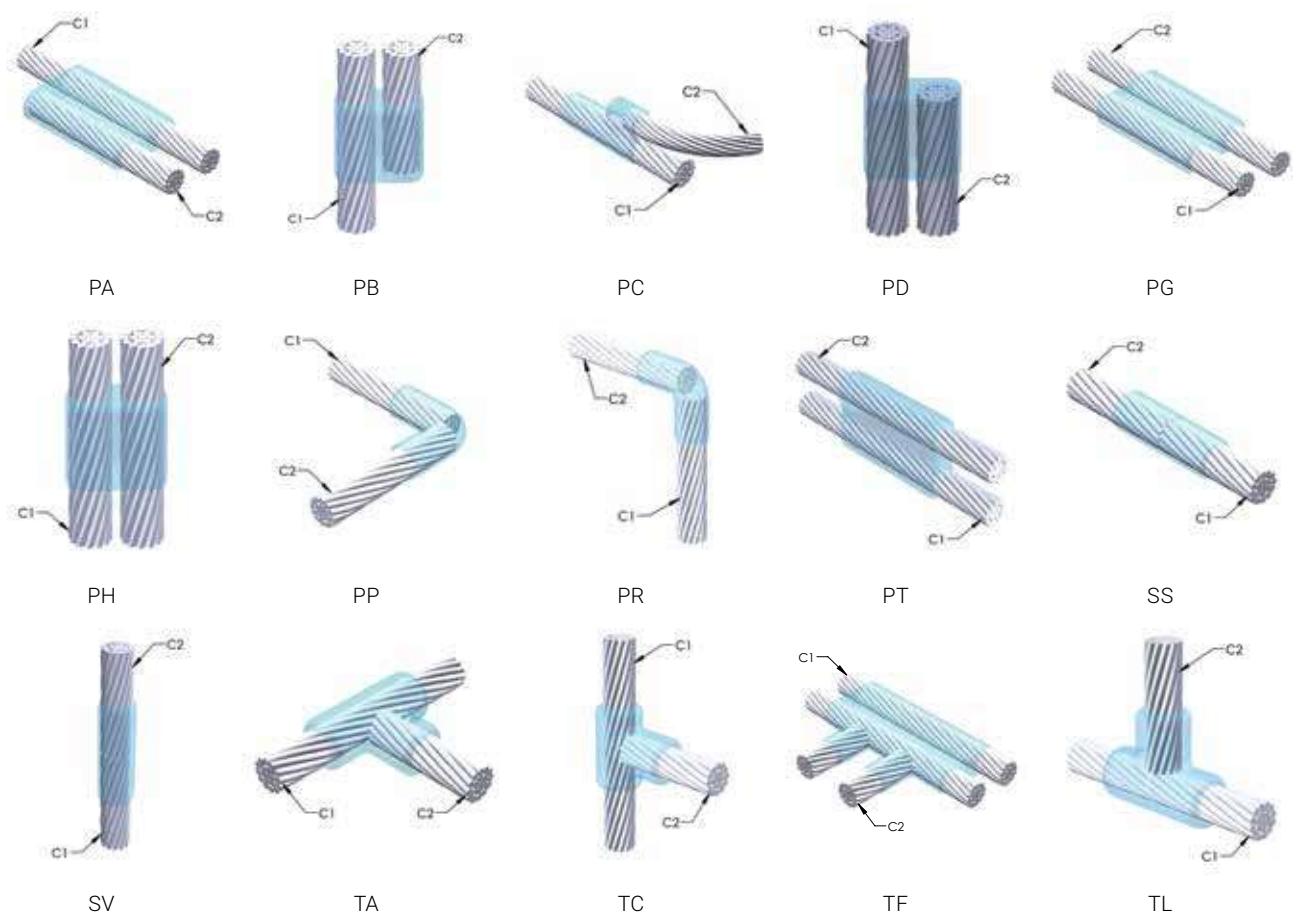

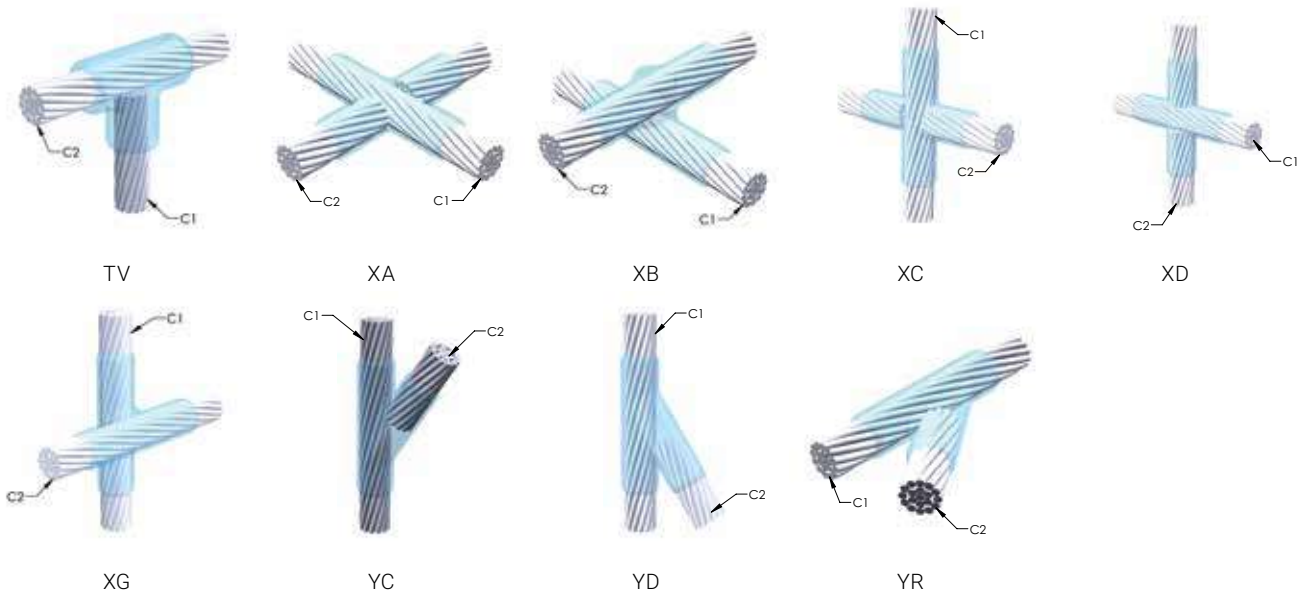

SS MOLDS



Global Part Number	Conductor 1	Conductor 2	Ease of Use	Price Key	Welding Material	Handle Clamp
SSCY6	120 mm ² Concentric	120 mm ² Concentric	Preferred	C	115 or 115PLUSF20, Sold Separately	L160, Sold Separately
SSCY4	70 mm ² Concentric	70 mm ² Concentric	Preferred	C	65 or 65PLUSF20, Sold Separately	L160, Sold Separately
SSCY2	35 mm ² Concentric	35 mm ² Concentric	Preferred	C	32 or 32PLUSF20, Sold Separately	L160, Sold Separately
SSCY5	95 mm ² Concentric	95 mm ² Concentric	Preferred	C	90 or 90PLUSF20, Sold Separately	L160, Sold Separately
SSCY8	185 mm ² Concentric	185 mm ² Concentric	Preferred	C	150 or 150PLUSF20, Sold Separately	L160, Sold Separately

PC MOLDS



Global Part Number	Conductor 1	Conductor 2	Ease of Use	Price Key	Welding Material	Handle Clamp
PCC2Q1H	4/0 Concentric	#6 Concentric	Preferred	C	90 or 90PLUSF20, Sold Separately	L160, Sold Separately



Global Part Number	Conductor 1	Conductor 2	Ease of Use	Price Key	Welding Material	Handle Clamp
TACY5Y3	95 mm ² Concentric	50 mm ² Concentric	Preferred	C	90 or 90PLUSF20, Sold Separately	L160, Sold Separately
TACY6Y1	120 mm ² Concentric	25 mm ² Concentric	Preferred	C	90 or 90PLUSF20, Sold Separately	L160, Sold Separately
TACY6Y5	120 mm ² Concentric	95 mm ² Concentric	Preferred	C	150 or 150PLUSF20, Sold Separately	L160, Sold Separately
TACY1Y1	25 mm ² Concentric	25 mm ² Concentric	Preferred	C	32 or 32PLUSF20, Sold Separately	L160, Sold Separately
TACY4Y2	70 mm ² Concentric	35 mm ² Concentric	Preferred	C	45 or 45PLUSF20, Sold Separately	L160, Sold Separately
TACY8Y7	185 mm ² Concentric	150 mm ² Concentric	Preferred	C	200 or 200PLUSF20, Sold Separately	L160, Sold Separately
TACY4Y6	70 mm ² Concentric	120 mm ² Concentric	Preferred	C	90 or 90PLUSF20, Sold Separately	L160, Sold Separately
TACY6Y3	120 mm ² Concentric	50 mm ² Concentric	Preferred	C	90 or 90PLUSF20, Sold Separately	L160, Sold Separately
TACY5Y6	95 mm ² Concentric	120 mm ² Concentric	Preferred	C	150 or 150PLUSF20, Sold Separately	L160, Sold Separately
TACY7Y7	150 mm ² Concentric	150 mm ² Concentric	Preferred	C	200 or 200PLUSF20, Sold Separately	L160, Sold Separately
TACY9Y6	240 mm ² Concentric	120 mm ² Concentric	Preferred	C	200 or 200PLUSF20, Sold Separately	L160, Sold Separately
TAC2Q1L	4/0 Concentric	#4 Concentric	Preferred	C	90 or 90PLUSF20, Sold Separately	L160, Sold Separately
TACY3Y3	50 mm ² Concentric	50 mm ² Concentric	Preferred	C	90 or 90PLUSF20, Sold Separately	L160, Sold Separately
TACY2Y2	35 mm ² Concentric	35 mm ² Concentric	Preferred	C	45 or 45PLUSF20, Sold Separately	L160, Sold Separately
TACY4Y1	70 mm ² Concentric	25 mm ² Concentric	Preferred	C	45 or 45PLUSF20, Sold Separately	L160, Sold Separately
TAC2Q2Q	4/0 Concentric	4/0 Concentric	Preferred	C	150 or 150PLUSF20, Sold Separately	L160, Sold Separately
TACY4Y4	70 mm ² Concentric	70 mm ² Concentric	Preferred	C	90 or 90PLUSF20, Sold Separately	L160, Sold Separately
TACY5Y2	95 mm ² Concentric	35 mm ² Concentric	Preferred	C	90 or 90PLUSF20, Sold Separately	L160, Sold Separately
TACY5Y7	95 mm ² Concentric	150 mm ² Concentric	Preferred	C	150 or 150PLUSF20, Sold Separately	L160, Sold Separately
TACY8Y8	185 mm ² Concentric	185 mm ² Concentric	Preferred	C	200 or 200PLUSF20, Sold Separately	L160, Sold Separately
TACY8Y5	185 mm ² Concentric	95 mm ² Concentric	Preferred	C	150 or 150PLUSF20, Sold Separately	L160, Sold Separately
TACY6Y4	120 mm ² Concentric	70 mm ² Concentric	Preferred	C	90 or 90PLUSF20, Sold Separately	L160, Sold Separately
TACY6Y2	120 mm ² Concentric	35 mm ² Concentric	Preferred	C	90 or 90PLUSF20, Sold Separately	L160, Sold Separately
TACY6Y6	120 mm ² Concentric	120 mm ² Concentric	Preferred	C	150 or 150PLUSF20, Sold Separately	L160, Sold Separately
TACY5Y5	95 mm ² Concentric	95 mm ² Concentric	Preferred	C	115 or 115PLUSF20, Sold Separately	L160, Sold Separately

Global Part Number	Conductor 1	Conductor 2	Ease of Use	Price Key	Welding Material	Handle Clamp
TACY9Y9	240 mm ² Concentric	240 mm ² Concentric	Preferred	C	150 x 2 or 300PLUSF20, Sold Separately	L160, Sold Separately
HDTAC2G1L	2/0 Concentric	#4 Concentric	Preferred	C	65 or 65PLUSF20, Sold Separately	L160, Sold Separately
HDTAC2Q2G	4/0 Concentric	2/0 Concentric	Preferred	C	150 or 150PLUSF20, Sold Separately	L160, Sold Separately
HDTAC2Q2Q	4/0 Concentric	4/0 Concentric	Preferred	C	250 or 250PLUSF20, Sold Separately	L160, Sold Separately
HDTAC2G1V	2/0 Concentric	#2 Concentric	Preferred	C	90 or 90PLUSF20, Sold Separately	L160, Sold Separately
HDTAC2Q1V	4/0 Concentric	#2 Concentric	Preferred	C	150 or 150PLUSF20, Sold Separately	L160, Sold Separately
HDTAC2Q1L	4/0 Concentric	#4 Concentric	Preferred	C	150 or 150PLUSF20, Sold Separately	L160, Sold Separately
HDTAC2G2G	2/0 Concentric	2/0 Concentric	Preferred	C	115 or 115PLUSF20, Sold Separately	L160, Sold Separately
HDTAC1L1L	#4 Concentric	#4 Concentric	Preferred	C	65 or 65PLUSF20, Sold Separately	L160, Sold Separately

XA MOLDS

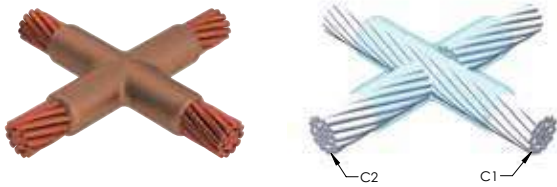

Global Part Number	Conductor 1	Conductor 2	Ease of Use	Price Key	Welding Material	Handle Clamp
XAC2Q2Q	4/0 Concentric	4/0 Concentric	Preferred	C	200 or 200PLUSF20, Sold Separately	L160, Sold Separately
XACY6Y5	120 mm ² Concentric	95 mm ² Concentric	Preferred	C	200 or 200PLUSF20, Sold Separately	L160, Sold Separately
XADY9Y9	240 mm ² Concentric	240 mm ² Concentric	Preferred	D	500 or 500PLUSF20, Sold Separately	L159, Sold Separately
XACY4Y4	70 mm ² Concentric	70 mm ² Concentric	Preferred	C	115 or 115PLUSF20, Sold Separately	L160, Sold Separately
XACY7Y7	150 mm ² Concentric	150 mm ² Concentric	Preferred	C	250 or 250PLUSF20, Sold Separately	L160, Sold Separately
XACY3Y3	50 mm ² Concentric	50 mm ² Concentric	Preferred	C	90 or 90PLUSF20, Sold Separately	L160, Sold Separately
XACY6Y6	120 mm ² Concentric	120 mm ² Concentric	Preferred	C	200 or 200PLUSF20, Sold Separately	L160, Sold Separately
XACY5Y5	95 mm ² Concentric	95 mm ² Concentric	Preferred	C	150 or 150PLUSF20, Sold Separately	L160, Sold Separately
XADY9Y6	240 mm ² Concentric	120 mm ² Concentric	Preferred	D	150 x 2 or 300PLUSF20, Sold Separately	L159, Sold Separately

XB MOLDS



Global Part Number	Conductor 1	Conductor 2	Ease of Use	Price Key	Welding Material	Handle Clamp
XB3Y6Y6	120 mm ² Concentric	120 mm ² Concentric	Preferred	3	150 x 2 or 300PLUSF20, Sold Separately	L163, Sold Separately
XBQY5Y5	95 mm ² Concentric	95 mm ² Concentric	Preferred	Q	250 or 250PLUSF20, Sold Separately	L160, Sold Separately
XBZY8Y8	185 mm ² Concentric	185 mm ² Concentric	Preferred	Z	500 or 500PLUSF20, Sold Separately	L159, Sold Separately
XBQY4Y4	70 mm ² Concentric	70 mm ² Concentric	Preferred	Q	200 or 200PLUSF20, Sold Separately	L160, Sold Separately
XB4Y8Y8	185 mm ² Concentric	185 mm ² Concentric	Preferred	4	500 or 500PLUSF20, Sold Separately	L164, Sold Separately
XBQY6Y6	120 mm ² Concentric	120 mm ² Concentric	Preferred	Q	150 x 2 or 300PLUSF20, Sold Separately	L160, Sold Separately

PG MOLDS

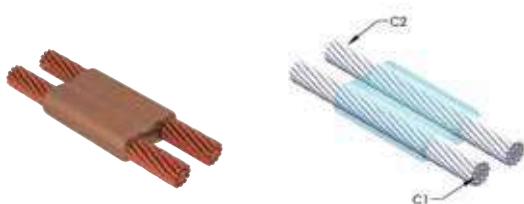

Global Part Number	Conductor 1	Conductor 2	Ease of Use	Price Key	Welding Material	Handle Clamp
PGCY5Y5	95 mm ² Concentric	95 mm ² Concentric	Easy	C	150 or 150PLUSF20, Sold Separately	L160, Sold Separately
PGCY6Y6	120 mm ² Concentric	120 mm ² Concentric	Easy	C	200 or 200PLUSF20, Sold Separately	L160, Sold Separately
PGCY4Y4	70 mm ² Concentric	70 mm ² Concentric	Easy	C	115 or 115PLUSF20, Sold Separately	L160, Sold Separately

PT MOLDS



Global Part Number	Conductor 1	Conductor 2	Ease of Use	Price Key	Welding Material	Handle Clamp
PTCY4Y2	70 mm ² Concentric	35 mm ² Concentric	Preferred	C	90 or 90PLUSF20, Sold Separately	L160, Sold Separately
PTCY8Y8	185 mm ² Concentric	185 mm ² Concentric	Preferred	C	150 x 2 or 300PLUSF20, Sold Separately	L160, Sold Separately
PTCY1Y1	25 mm ² Concentric	25 mm ² Concentric	Preferred	C	45 or 45PLUSF20, Sold Separately	L160, Sold Separately
PTCY5Y4	95 mm ² Concentric	70 mm ² Concentric	Preferred	C	150 or 150PLUSF20, Sold Separately	L160, Sold Separately
PTCY6Y6	120 mm ² Concentric	120 mm ² Concentric	Preferred	C	250 or 250PLUSF20, Sold Separately	L160, Sold Separately
PTCY3Y1	50 mm ² Concentric	25 mm ² Concentric	Preferred	C	90 or 90PLUSF20, Sold Separately	L160, Sold Separately
PTCY4Y4	70 mm ² Concentric	70 mm ² Concentric	Preferred	C	115 or 115PLUSF20, Sold Separately	L160, Sold Separately
PTCY2Y2	35 mm ² Concentric	35 mm ² Concentric	Preferred	C	65 or 65PLUSF20, Sold Separately	L160, Sold Separately
PTCY3Y3	50 mm ² Concentric	50 mm ² Concentric	Preferred	C	90 or 90PLUSF20, Sold Separately	L160, Sold Separately
PTCY4Y3	70 mm ² Concentric	50 mm ² Concentric	Preferred	C	115 or 115PLUSF20, Sold Separately	L160, Sold Separately
PTCY5Y5	95 mm ² Concentric	95 mm ² Concentric	Preferred	C	200 or 200PLUSF20, Sold Separately	L160, Sold Separately
PTCY5Y3	95 mm ² Concentric	50 mm ² Concentric	Preferred	C	150 or 150PLUSF20, Sold Separately	L160, Sold Separately
PTCY8Y6	185 mm ² Concentric	120 mm ² Concentric	Preferred	C	250 or 250PLUSF20, Sold Separately	L160, Sold Separately

ND MOLDS

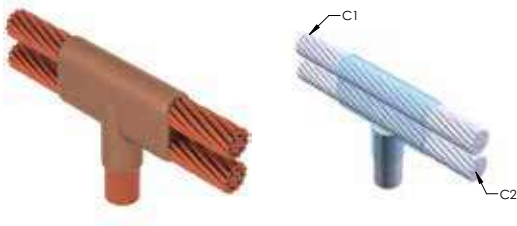

Global Part Number	Conductor 1	Conductor 2	Ease of Use	Ground Rod Diameter, Nominal <Nom>	Ground Rod Type	Price Key	Welding Material	Handle Clamp
NDF332Q	4/0 Concentric	4/0 Concentric	Preferred	3/4"	Steel	F	150 x 2 or 300PLUSF20, Sold Separately	L159, Sold Separately

GROUND ROD SPLICE/GROUNDING RECEPTACLE



- Forms a permanent, low resistance connection
- Provides a molecular bond
- nVent ERICO Cadweld Exothermic Connections are rated with the same current capacity as the conductor
- Portable installation equipment with no external source of power required
- Installers can be easily trained to make nVent ERICO Cadweld Exothermic Connections
- Connections can be visually inspected

nVent ERICO Cadweld graphite molds are designed and engineered for thousands of connection styles and conductor combinations

XX-X-XX-XX-L-M-W

XX	Mold Family	
X	Price Key	
XX	Ground Rod Code	
XX	Ground Plate/Grounding Receptacle	
L*	Split Crucible	Crucible section is split on molds designed with horizontal opening for easier cleaning
M*	Mold Only	
W*	Wear Plates	Reduce mechanical abrasion of molds at cable entry points

* Empty if none

MOLD FAMILY



GB

GE

Global Part Number	Connects To	Ease of Use	Ground Rod Diameter, Nominal <Nom>	Ground Rod Type	Price Key	Welding Material	Handle Clamp
GEC16	Identical Ground Rod	Preferred	5/8"	Copper-bonded	C	150 or 150PLUSF20, Sold Separately	L160, Sold Separately

CABLE TO GROUND ROD OR OTHER ROUNDS



- Forms a permanent, low resistance connection
- Provides a molecular bond
- nVent ERICO Cadweld Exothermic Connections are rated with the same current capacity as the conductor
- Portable installation equipment with no external source of power required
- Installers can be easily trained to make nVent ERICO Cadweld Exothermic Connections
- Connections can be visually inspected

nVent ERICO Cadweld graphite molds are designed and engineered for thousands of connection styles and conductor combinations.

XX-X-XX-XX-L-M-W		
XX	Mold Family	
X	Price Key	
XX	Ground Rod Code	
XX	Ground Plate/Grounding Receptacle	
L*	Split Crucible	Crucible section is split on molds designed with horizontal opening for easier cleaning
M*	Mold Only	
W*	Wear Plates	Reduce mechanical abrasion of molds at cable entry points

* Empty if none

MOLD FAMILY

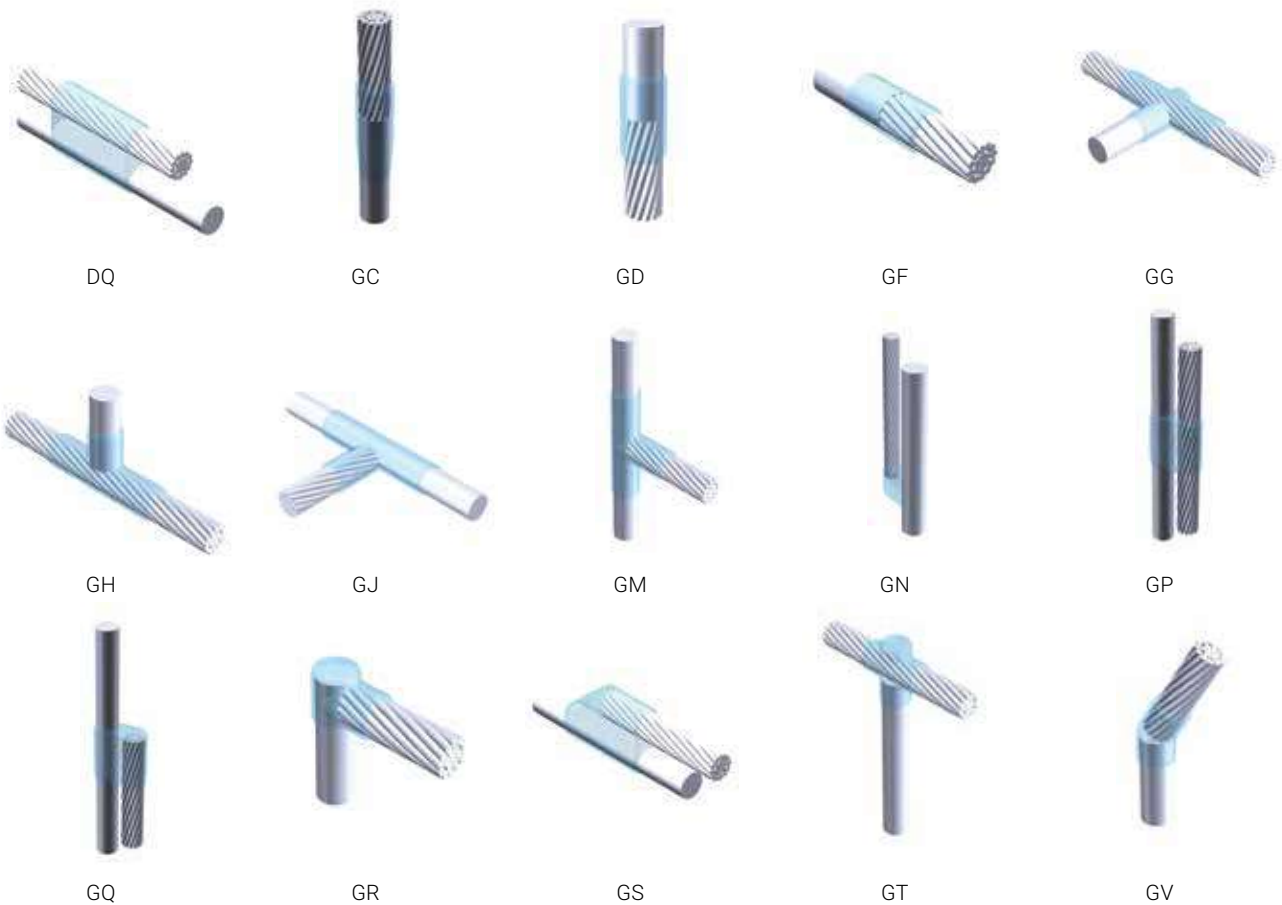



GW



GX



GY



VW

GR MOLDS



Global Part Number	Conductor Size	Ease of Use	Ground Rod Diameter, Nominal <Nom>	Ground Rod Type	Price Key	Welding Material	Handle Clamp
GRC18Y6	120 mm ² Concentric	Preferred	3/4"	Copper-bonded	C	90 or 90PLUSF20, Sold Separately	L160, Sold Separately
GRC16Y3	50 mm ² Concentric	Preferred	5/8"	Copper-bonded	C	90 or 90PLUSF20, Sold Separately	L160, Sold Separately

GT MOLDS



Global Part Number	Conductor Size	Ease of Use	Ground Rod Diameter, Nominal <Nom>	Ground Rod Type	Price Key	Welding Material	Handle Clamp
GTCP200Y6	120 mm ² Concentric	Preferred	20.000 mm	Steel	C	150 or 150PLUSF20, Sold Separately	L160, Sold Separately
GTC16Y3	50 mm ² Concentric	Preferred	5/8"	Copper-bonded	C	90 or 90PLUSF20, Sold Separately	L160, Sold Separately
GTC18Y4	70 mm ² Concentric	Preferred	3/4"	Copper-bonded	C	115 or 115PLUSF20, Sold Separately	L160, Sold Separately
GTC16Y5	95 mm ² Concentric	Preferred	5/8"	Copper-bonded	C	115 or 115PLUSF20, Sold Separately	L160, Sold Separately
GTC162Q	4/0 Concentric	Preferred	5/8"	Copper-bonded	C	115 or 115PLUSF20, Sold Separately	L160, Sold Separately
GTC16Y6	120 mm ² Concentric	Preferred	5/8"	Copper-bonded	C	150 or 150PLUSF20, Sold Separately	L160, Sold Separately
GTC18Y6	120 mm ² Concentric	Preferred	3/4"	Copper-bonded	C	150 or 150PLUSF20, Sold Separately	L160, Sold Separately
GTC16Y2	35 mm ² Concentric	Preferred	5/8"	Copper-bonded	C	90 or 90PLUSF20, Sold Separately	L160, Sold Separately
GTC16Y4	70 mm ² Concentric	Preferred	5/8"	Copper-bonded	C	115 or 115PLUSF20, Sold Separately	L160, Sold Separately
GTC18Y8	185 mm ² Concentric	Preferred	3/4"	Copper-bonded	C	200 or 200PLUSF20, Sold Separately	L160, Sold Separately

GY MOLDS



Global Part Number	Conductor Size	Ease of Use	Ground Rod Diameter, Nominal <Nom>	Ground Rod Type	Price Key	Welding Material	Handle Clamp
GYR181H	#6 Concentric	Preferred	3/4"	Copper-bonded	R	90 or 90PLUSF20, Sold Separately	L160, Sold Separately

GF MOLDS



Global Part Number	Conductor Size	Ease of Use	Ground Rod Diameter, Nominal <Nom>	Ground Rod Type	Price Key	Welding Material	Handle Clamp
GFC16Y3	50 mm ² Concentric	Preferred	5/8"	Copper-bonded	C	90 or 90PLUSF20, Sold Separately	L160, Sold Separately

CABLE TO STEEL



- Forms a permanent, low resistance connection
- Provides a molecular bond
- nVent ERICO Cadweld Exothermic Connections are rated with the same current capacity as the conductor
- Portable installation equipment with no external source of power required
- Installers can be easily trained to make nVent ERICO Cadweld Exothermic Connections
- Connections can be visually inspected

nVent ERICO Cadweld graphite molds are designed and engineered for thousands of connection styles and conductor combinations.

W-XX-X-XX-LH-XX-L-M		
W*	Wear Plates	Reduce mechanical abrasion of molds at cable entry points
XX	Mold Family	
X	Price Key	
XX	Conductor Code	
LH	Weld End	"LH = Weld on left end of conductor RH = Weld on right end of conductor (For Mold Families HG, VL, and VN only)"
XX	Pipe Size	
L*	Split Crucible	Crucible section is split on molds designed with horizontal opening for easier cleaning
M*	Mold Only	

* Empty if none

MOLD FAMILY

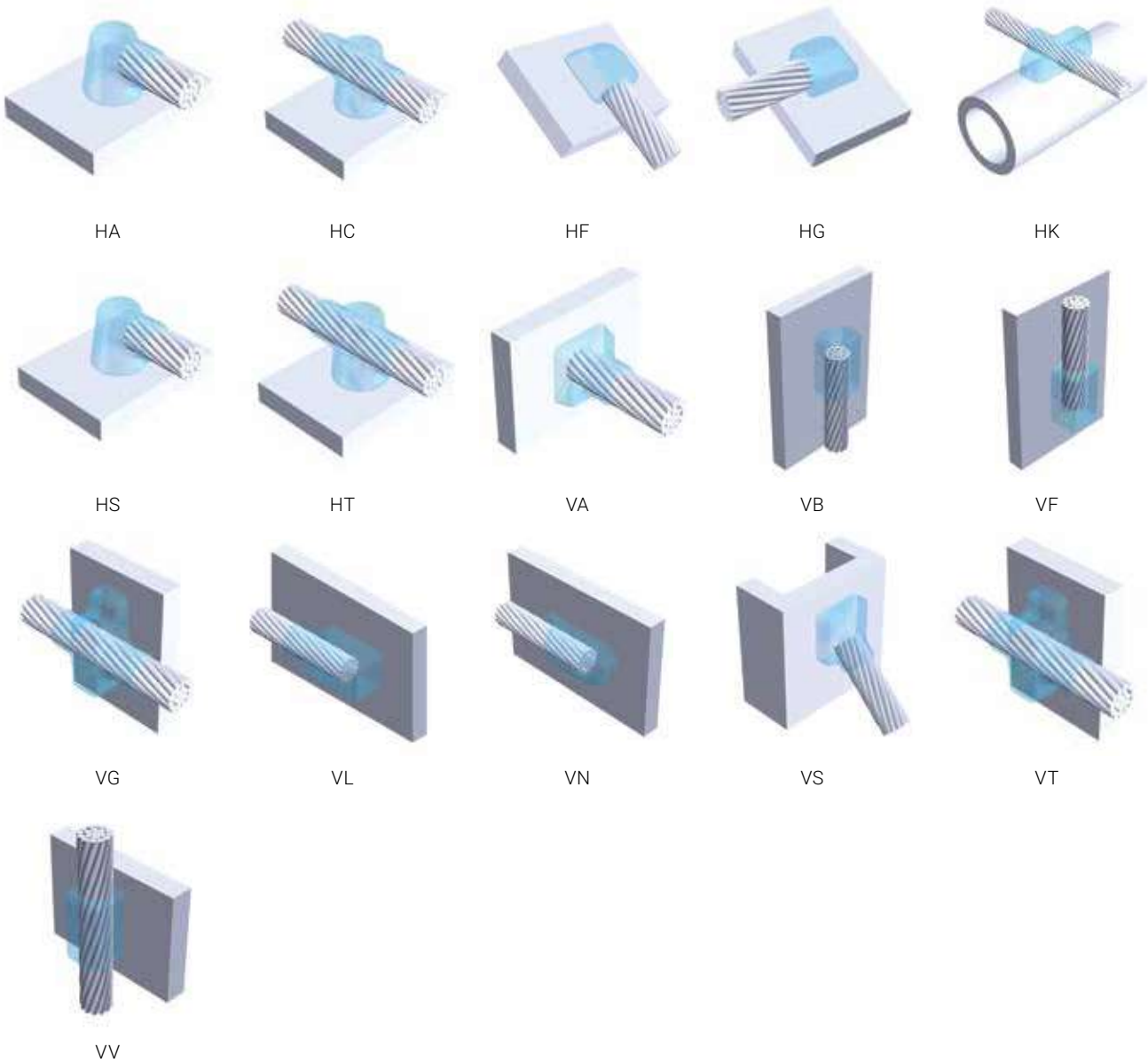

HA MOLDS

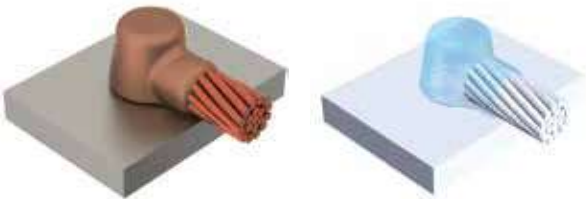

Global Part Number	Conductor Size	Connects To	Ease of Use	Price Key	Pipe Size <Min>	Pipe Size <Max>	Outer Diameter (mm) <Min>	Outer Diameter (mm) <Max>	NB/DN (mm) <Min>	NB/DN (mm) <Max>	Welding Material
HAH2G8C	2/0 Concentric	Steel Pipe	Preferred	H	6"	10"	158.8 mm	273.1 mm	150	250	90 or 90PLUSF20, Sold Separately
HAH2G20C	2/0 Concentric	Steel Pipe	Preferred	H	12"	24"	323.9 mm	609.6 mm	300	600	90 or 90PLUSF20, Sold Separately

VS MOLDS

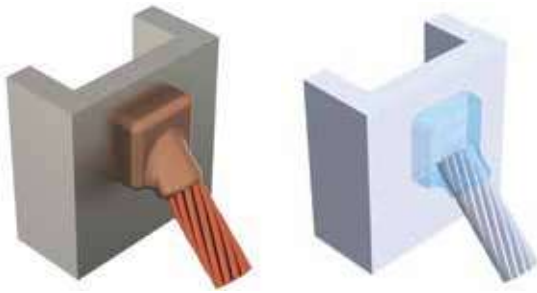

Global Part Number	Conductor Size	Connects To	Ease of Use	Price Key	Pipe Size <Min>	Outer Diameter (mm) <Min>	NB/DN (mm) <Min>	Welding Material	Handle Clamp	Mold Family
VSCY3	50 mm ² Concentric	Steel Pipe or Flat Surface	Preferred	C	24"	609.6 mm	600	90 or 90PLUSF20, Sold Separately	L160 and B396, Sold Separately	VS
VSCY4	70 mm ² Concentric	Steel Pipe or Flat Surface	Preferred	C	24"	609.6 mm	600	90 or 90PLUSF20, Sold Separately	L160 and B396, Sold Separately	VS

VB MOLDS

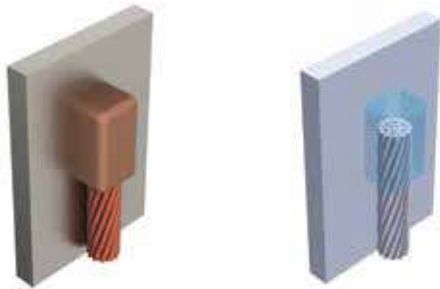

Global Part Number	Conductor Size	Connects To	Ease of Use	Price Key	Pipe Size <Min>	Outer Diameter (mm) <Min>	NB/DN (mm) <Min>	Welding Material	Handle Clamp	Mold Family
VBC2G	2/0 Concentric	Steel Pipe or Flat Surface	Easy	C	24"	609.6 mm	600	115 or 115PLUSF20, Sold Separately	L160 and B396, Sold Separately	VB
VBCY6	120 mm ² Concentric	Steel Pipe or Flat Surface	Easy	C	24"	609.6 mm	600	200 or 200PLUSF20, Sold Separately	L160 and B396, Sold Separately	VB

VG MOLDS

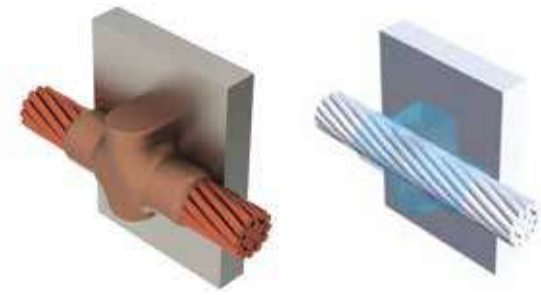

Global Part Number	Conductor Size	Connects To	Ease of Use	Price Key	Pipe Size <Min>	Outer Diameter (mm) <Min>	NB/DN (mm) <Min>	Welding Material	Handle Clamp
VGCY2	35 mm ² Concentric	Steel Pipe or Flat Surface	Preferred	C	24"	609.6 mm	600	45 or 45PLUSF20, Sold Separately	L160, Sold Separately
VGCY4	70 mm ² Concentric	Steel Pipe or Flat Surface	Preferred	C	24"	609.6 mm	600	115 or 115PLUSF20, Sold Separately	L160, Sold Separately
VGPY1M	25 mm ² Concentric	Steel Pipe or Flat Surface	Preferred	P	24"	609.6 mm	600	45 or 45PLUSF20, Sold Separately	B399A, Sold Separately
VGCY3	50 mm ² Concentric	Steel Pipe or Flat Surface	Preferred	C	24"	609.6 mm	600	115 or 115PLUSF20, Sold Separately	L160, Sold Separately
VGCY1	25 mm ² Concentric	Steel Pipe or Flat Surface	Preferred	C	24"	609.6 mm	600	45 or 45PLUSF20, Sold Separately	L160, Sold Separately

CABLE TO LUG OR BUSBAR



- Forms a permanent, low resistance connection
- Provides a molecular bond
- nVent ERICO Cadweld Exothermic Connections are rated with the same current capacity as the conductor
- Portable installation equipment with no external source of power required
- Installers can be easily trained to make nVent ERICO Cadweld Exothermic Connections
- Connections can be visually inspected
- Mold Families LA and LE can be used with straight or offset lugs

nVent ERICO Cadweld graphite molds are designed and engineered for thousands of connection styles and conductor combinations.

XX-X-XX-XX-L-M-W		
XX	Mold Family	
X	Price Key	
XX	Lug/Busbar Size	
XX	Conductor Code	
L*	Split Crucible	Crucible section is split on molds designed with horizontal opening for easier cleaning
M*	Mold Only	
W*	Wear Plates	Reduce mechanical abrasion of molds at cable entry points

* Empty if none

MOLD FAMILY

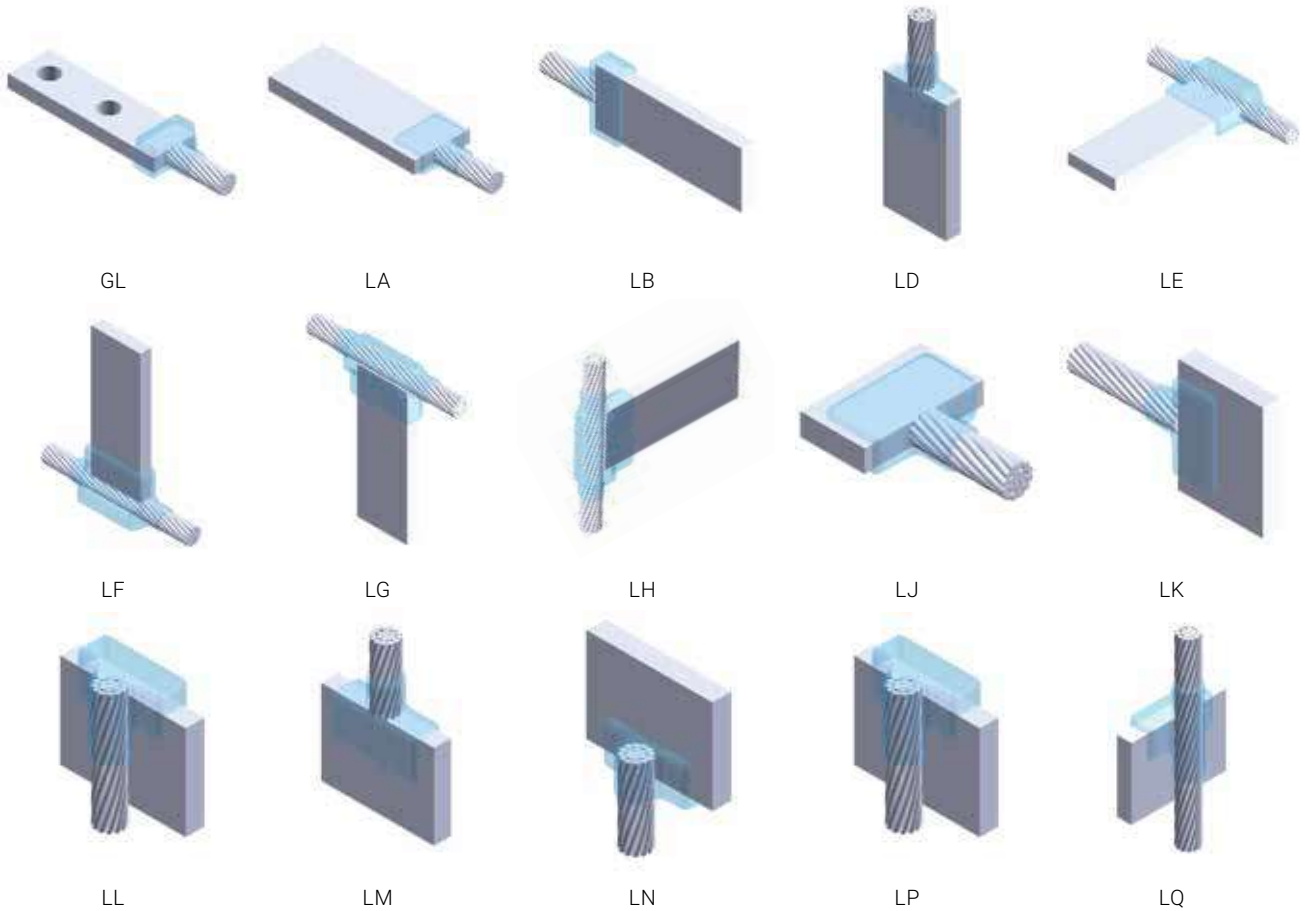

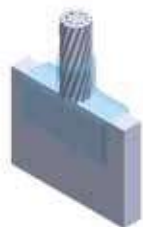

LR

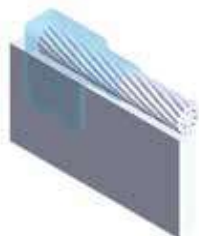

LV

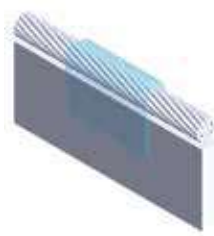

LW



LX

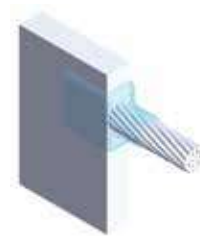

MG

LA MOLDS



Global Part Number	Conductor Size	Ease of Use	Lug/Busbar Size	Price Key	Welding Material	Handle Clamp
LACY5CAJ	95 mm ² Concentric	Preferred	3 mm x 25 mm	C	65 or 65PLUSF20, Sold Separately	L160, Sold Separately

LJ MOLDS



Global Part Number	Conductor Size	Ease of Use	Lug/Busbar Size	Price Key	Welding Material	Handle Clamp
LJCEALY4	70 mm ² Concentric	Preferred	4 mm x 40 mm and wider	C	90 or 90PLUSF20, Sold Separately	L160, Sold Separately
LJCEALY3	50 mm ² Concentric	Preferred	4 mm x 40 mm and wider	C	90 or 90PLUSF20, Sold Separately	L160, Sold Separately
LJCEALY2	35 mm ² Concentric	Preferred	4 mm x 40 mm and wider	C	65 or 65PLUSF20, Sold Separately	L160, Sold Separately
LJCPALY4	70 mm ² Concentric	Preferred	6 mm x 40 mm and wider	C	90 or 90PLUSF20, Sold Separately	L160, Sold Separately

GROUND ROD TO LUG OR BUSBAR



- Forms a permanent, low resistance connection
- Provides a molecular bond
- nVent ERICO Cadweld Exothermic Connections are rated with the same current capacity as the conductor
- Portable installation equipment with no external source of power required
- Installers can be easily trained to make nVent ERICO Cadweld Exothermic Connections
- Connections can be visually inspected
- Mold Families LA and LE can be used with straight or offset lugs

nVent ERICO Cadweld graphite molds are designed and engineered for thousands of connection styles and conductor combinations.

CM MOLDS

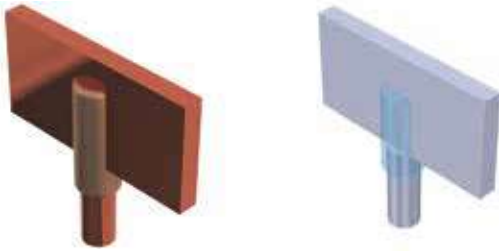

Global Part Number	Ease of Use	Ground Rod Diameter, Nominal <Nom>	Ground Rod Type	Lug/Busbar Size	Price Key	Welding Material	Handle Clamp
CMC16EAJ	Difficult	5/8"	Copper-bonded	4 mm x 25 mm	C	115 or 115PLUSF20, Sold Separately	L160 and B399P, Sold Separately

CP MOLDS



Global Part Number	Ease of Use	Ground Rod Diameter, Nominal <Nom>	Ground Rod Type	Lug/Busbar Size	Price Key	Welding Material	Handle Clamp
CPC16EAJ	Easy	5/8"	Copper-bonded	4 mm x 25 mm and wider	C	150 or 150PLUSF20, Sold Separately	L160 and B399P, Sold Separately

BUSBAR TO BUSBAR

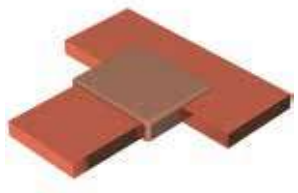

- Forms a permanent, low resistance connection
- Provides a molecular bond
- nVent ERICO Cadweld Exothermic Connections are rated with the same current capacity as the conductor
- Portable installation equipment with no external source of power required
- Installers can be easily trained to make nVent ERICO Cadweld Exothermic Connections
- Connections can be visually inspected

nVent ERICO Cadweld graphite molds are designed and engineered for thousands of connection styles and conductor combinations.

XX-X-XX-XX-L-M-W

XX	Mold Family	
X	Price Key	
XX	Lug/Busbar Size 1	
XX	Lug/Busbar Size 2	
L*	Split Crucible	Crucible section is split on molds designed with horizontal opening for easier cleaning
M*	Mold Only	
W*	Wear Plates	Reduce mechanical abrasion of molds at cable entry points

* Empty if none

MOLD FAMILY

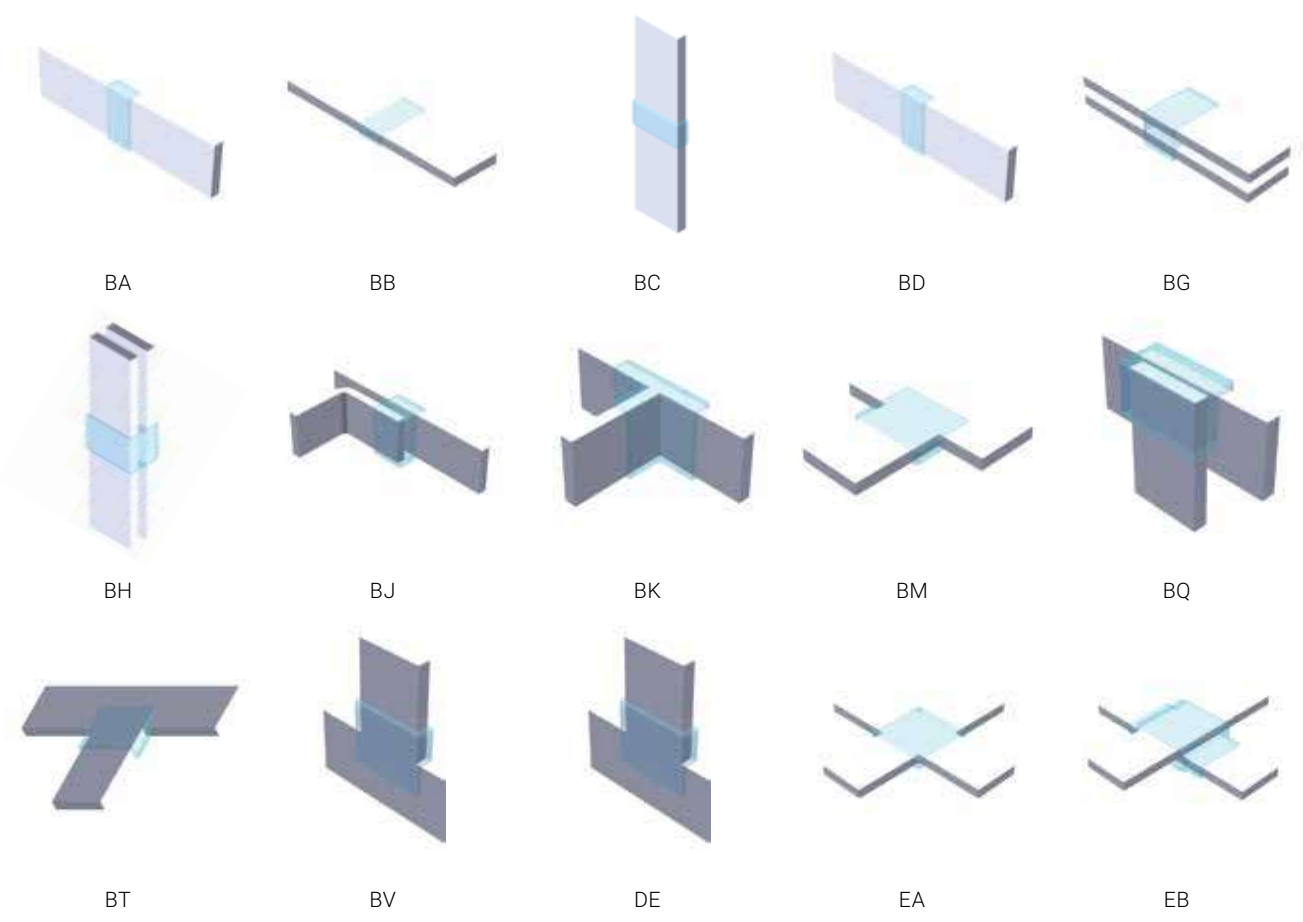



EC



ED

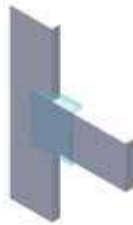

EE



EN



EP



ER



TW

BA MOLDS

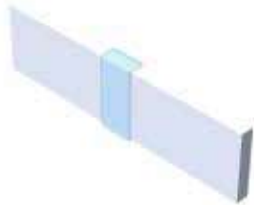
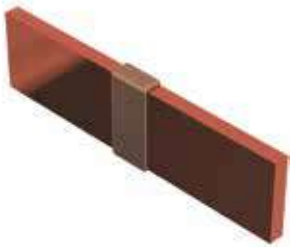

Global Part Number	Ease of Use	Price Key	Lug/Busbar Size 1	Lug/Busbar Size 2	Welding Material	Handle Clamp
BACEAL	Preferred	C	4 mm x 40 mm	4 mm x 40 mm	150 or 150PLUSF20, Sold Separately	L160, Sold Separately

BB MOLDS



Global Part Number	Ease of Use	Price Key	Lug/Busbar Size 1	Lug/Busbar Size 2	Welding Material	Handle Clamp
BBREAM	Easy	R	4 mm x 50 mm	4 mm x 50 mm	200 or 200PLUSF20, Sold Separately	L160, Sold Separately
BBCEAL	Easy	C	4 mm x 40 mm	4 mm x 40 mm	150 or 150PLUSF20, Sold Separately	L160, Sold Separately
BBCAJ	Easy	C	3 mm x 25 mm	3 mm x 25 mm	90 or 90PLUSF20, Sold Separately	L160, Sold Separately
BBCPAJ	Easy	C	6 mm x 25 mm	6 mm x 25 mm	115 or 115PLUSF20, Sold Separately	L160, Sold Separately

BM MOLDS

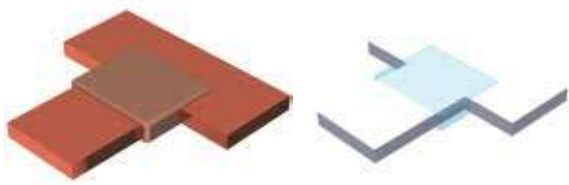

Global Part Number	Ease of Use	Price Key	Lug/Busbar Size 1	Lug/Busbar Size 2	Welding Material	Handle Clamp
BMCEAJEAJ	Easy	C	4 mm x 25 mm	4 mm x 25 mm	90 or 90PLUSF20, Sold Separately	L160, Sold Separately
BMCFALFAL	Easy	C	5 mm x 40 mm	5 mm x 40 mm	150 or 150PLUSF20, Sold Separately	L160, Sold Separately
BMDPAMPAM	Easy	D	6 mm x 50 mm	6 mm x 50 mm	250 or 250PLUSF20, Sold Separately	L159, Sold Separately
BMCEALEAL	Easy	C	4 mm x 40 mm	4 mm x 40 mm	150 or 150PLUSF20, Sold Separately	L160, Sold Separately
BMCCAJCAJ	Easy	C	3 mm x 25 mm	3 mm x 25 mm	90 or 90PLUSF20, Sold Separately	L160, Sold Separately
BMDEAMEAM	Easy	D	4 mm x 50 mm	4 mm x 50 mm	250 or 250PLUSF20, Sold Separately	L159, Sold Separately

BK MOLDS

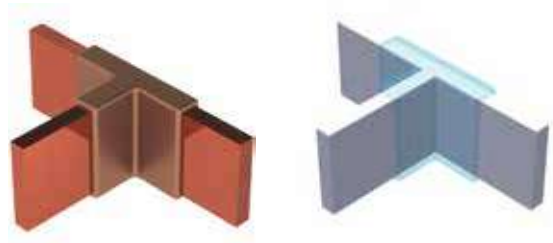

Global Part Number	Ease of Use	Price Key	Lug/Busbar Size 1	Lug/Busbar Size 2	Welding Material	Handle Clamp
BKEALEAL	Easy	E	4 mm x 40 mm	4 mm x 40 mm	200 or 200PLUSF20, Sold Separately	L160, Sold Separately

EB MOLDS

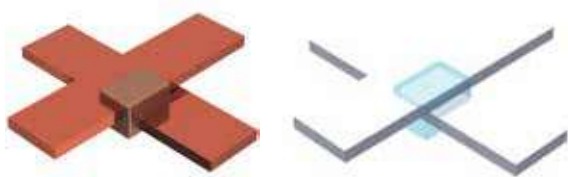

Global Part Number	Ease of Use	Price Key	Lug/Busbar Size 1	Lug/Busbar Size 2	Welding Material	Handle Clamp
EBCFALFAL	Most Difficult	C	5 mm x 40 mm and wider	5 mm x 40 mm and wider	250 or 250PLUSF20, Sold Separately	L160, Sold Separately



nVent ERICO Cadweld Welding Material, Tools and Accessories

nVent ERICO Cadweld Plus

Cadweld Plus connections offer all the benefits of conventional Cadweld connections:

- Current carrying capacity equal to or greater than that of the conductor
- Withstand repeated fault currents without failing during operation
- Permanent, molecular bond that will not loosen or corrode, resulting in a connection with a lifetime equal to that of the installation
- Join copper to copper, copper to galvanized or plain steel, copper to copper clad steel, copper to bronze/ brass/ stainless steel, steel to steel, etc.
- No external power or heat source required
- Quality Assurance Inspection is easy and visual
- Minimal installation training required
- Exceed requirements of "IEEE Std. 837-2014 -Std. for Qualifying Permanent Connections Used In Substation Grounding"



The Cadweld molecular bond will last the lifetime of the conductors.

CADWELD PLUS

The ultimate welded connection that will never loosen, corrode or increase in resistance.

nVent ERICO is dedicated to continuous product improvement to meet its customers' needs and maintain the highest level of satisfaction. The introduction of Cadweld electrical connections in 1938 enabled them to be quickly recognized as the ultimate connection for rail, cathodic, power and grounding applications.

Continuing the tradition of technical leadership, Cadweld Plus was developed as a simplified method of performing exothermically welded electrical connections. This trusted system now features a new Cadweld Plus cup design for the integrated welding material package which has streamlined the installation process by eliminating ignition materials.

The tamper proof, integrated welding material package consists of a steel cup containing Cadweld patented welding material alloys and an ignition source. This newly shaped welding material package is designed for use in all standard Cadweld molds, including Cadweld Multi. Once placed in the Cadweld mold, the welding material is electronically ignited using a simple battery-powered control unit with a six-foot lead.

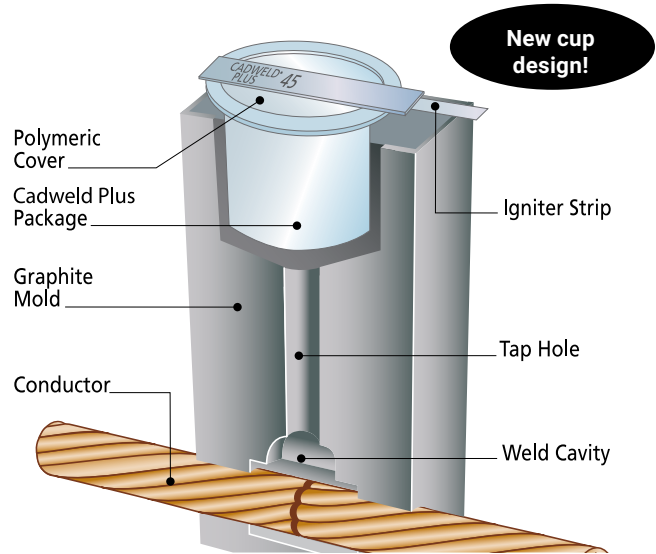

Feature	Benefits
Integrated Welding Material Package	<ul style="list-style-type: none"> • Simplifies training and set up • Saves labor • Simplifies cleaning
Color Coded Welding Material	<ul style="list-style-type: none"> • Helps reduce risk of misapplication • Simple visual verification of correct welding material size
Electronic Control Unit	<ul style="list-style-type: none"> • No starting material required • Easy ignition
Replaceable Six or Fifteen Foot Control Unit Lead	<ul style="list-style-type: none"> • Increased flexibility in hard to reach areas

Cadweld Plus

- Consists of a tamper proof, disposable, moisture-resistant welding material cup. The welding material, disk and ignition source are incorporated into the self-contained package
- Long shelf life
- Completes welds at distances of up to 6 ft/1.8 meters (up to 15 ft/4.6 meters with optional lead)
- Requires minimum components – no starting material, no disks, no flint igniters
- Easy to handle, store and transport – by air, land or sea in unlimited quantities

- Reduces installation time by 20%
- Has color-coded welding material containers – by size and alloy type – for easy identification
- Has electronic ignition with a CE/UL battery powered controller box that is designed for 600 connections with one set of 8 standard AA batteries (included) – requiring no special batteries or chargers
- Designed for use in standard Cadweld molds including Cadweld Multi

Installation Is Easy! 4 Simple Steps For Permanently Welded Electrical Connections



Self contained welding material package



1 Insert Cadweld Plus cup into mold (may require use of a cover/baffle)



2 Attach control unit termination clip to ignition strip



3 Press and hold control unit switch and wait for the ignition



4 Open the mold and remove the expended steel cup – no special disposal required

Cadweld Plus Control Unit initiates the reaction of the metal crucible. The standard unit includes a 6-foot (1.8 meter) high temperature control unit lead. The lead attaches to the ignition strip using a custom made, purpose-designed termination clip.

After the termination clip is installed on the ignition strip, the installer pushes and holds the ignition button to start a charging and discharging sequence. Within a few seconds the control unit sends a predetermined voltage to the ignition strip and the reaction is initiated.

NVENT ERICO CADWELD WELDING MATERIAL, F20

FEATURE

- Mixture consists mainly of copper oxide and aluminum
- Primarily used in grounding and bonding applications
- Welding material is in the top of the tube and starting material is in the bottom of the tube
- Packaged by size in plastic tubes with clear caps
- Tubes packaged in plastic boxes along with metal disks
- Each welded connection uses a single disk
- Non-explosive
- Not subject to spontaneous ignition
- See specific nVent ERICO Cadweld connection details to determine welding material requirements



Part Number	Article Number	Standard Packaging Quantity
115	163590	10 pc
15	163000	20 pc
150	163010	10 pc
200	163020	10 pc
25	163030	20 pc
250	163040	10 pc
32	163050	20 pc
45	163060	20 pc
500	163070	10 pc
65	163080	20 pc
90	163090	10 pc

NVENT ERICO CADWELD PLUS WELDING MATERIAL, F20

FEATURE

- Mixture consists mainly of copper oxide and aluminum
- Primarily used in grounding and bonding applications
- Integrated welding material package
- Color coding by size for easy identification
- Electronic ignition
- No starting material required
- Non-explosive
- Not subject to spontaneous ignition
- See specific nVent ERICO Cadweld connection details to determine welding material requirements



Part Number	Article Number	Color Code Ring	Certifications	Standard Packaging Quantity
115PLUSF20	165706	Orange	cULus	10 pc
150PLUSF20	165707	Dark Blue	cULus	10 pc
15PLUSF20	165700	Black	cULus	20 pc
200PLUSF20	165708	Yellow	cULus	10 pc
250PLUSF20	165709	Purple	cULus	10 pc

Part Number	Article Number	Color Code Ring	Certifications	Standard Packaging Quantity
25PLUSF20	165701	Red	cULus	20 pc
300PLUSF20	165710	Light Green	cULus	10 pc
32PLUSF20	165702	White	cULus	20 pc
400PLUSF20	165711	Brown		10 pc
45PLUSF20	165703	Light Blue	cULus	20 pc
500PLUSF20	165712	Light Brown		10 pc
600PLUSF20	-	White		10 pc
65PLUSF20	165704	Dark Green	cULus	20 pc
750PLUSF20	164996	White		5 pc
90PLUSF20	165705	Gray	cULus	10 pc

nVENT ERICO CADWELD EXOLON WELDING MATERIAL, F20

FEATURE

- Mixture consists mainly of copper oxide and aluminum
- Primarily used in grounding and bonding applications
- Designed for applications where low smoke emission is required
- Welding material packaged in tubes without starting material
- Tubes packaged with filters and igniters
- Electronic ignition
- Each weld uses one igniter
- Not subject to spontaneous ignition
- See specific nVent ERICO Cadweld connection details to determine welding material requirements



Part Number
XL115
XL15
XL25
XL32
XL45
XL90

nVENT ERICO CADWELD ONE SHOT, CABLE TO GROUND ROD



Mold Family



GR (ONE SHOT)



GT (ONE SHOT)



NT (ONE SHOT)



NX (ONE SHOT)

FEATURE

- Single use ceramic mold which eliminates the need for a graphite mold and handle clamp/frame
- Produces a permanent connection that will not loosen or corrode
- Fits plain copper-bonded, threaded copper-bonded, full-size galvanized and stainless steel ground rods
- NEC® compliant



Part Number	Article Number	Mold Family	Ground Rod Diameter, Nominal	Ground Rod Diameter, Actual	Connection, Solid	Connection, Stranded
Welding Material Type: nVent ERICO Cadweld Plus						
GR1141GPLUS	165750	GR (ONE SHOT)	1/2"	11.2 – 12.9 mm	10 mm ²	10 mm ²
GR1141LPLUS	165751	GR (ONE SHOT)	1/2"	11.2 – 12.9 mm		16 mm ²
GR1141VPLUS	165752	GR (ONE SHOT)	1/2"	11.2 – 12.9 mm	50 mm ²	25 mm ² , 35 mm ²
GR1161GPLUS	165753	GR (ONE SHOT)	5/8"	14.1 – 16.1 mm	10 mm ²	10 mm ²
GR1161LPLUS	165754	GR (ONE SHOT)	5/8"	14.1 – 16.1 mm		16 mm ²
GR1161VPLUS	165755	GR (ONE SHOT)	5/8"	14.1 – 16.1 mm	50 mm ²	25 mm ² , 35 mm ²
GR1162CPLUS	165756	GR (ONE SHOT)	5/8"	14.1 – 16.1 mm		50 mm ²
GR1162GPLUS	165757	GR (ONE SHOT)	5/8"	14.1 – 16.1 mm	70 mm ²	70 mm ²
GR1162QPLUS	165758	GR (ONE SHOT)	5/8"	14.1 – 16.1 mm		95 mm ²
GR1181GPLUS	165759	GR (ONE SHOT)	3/4"	17.1 – 19.4 mm	10 mm ²	10 mm ²
GR1181LPLUS	165760	GR (ONE SHOT)	3/4"	17.1 – 19.4 mm		16 mm ²
GR1181VPLUS	165761	GR (ONE SHOT)	3/4"	17.1 – 19.4 mm	50 mm ²	25 mm ² , 35 mm ²
GR1182CPLUS	165762	GR (ONE SHOT)	3/4"	17.1 – 19.4 mm		50 mm ²
GR1182GPLUS	165763	GR (ONE SHOT)	3/4"	17.1 – 19.4 mm	70 mm ²	70 mm ²
GR1182QPLUS	165764	GR (ONE SHOT)	3/4"	17.1 – 19.4 mm		95 mm ²
GT1141GPLUS	165765	GT (ONE SHOT)	1/2"	11.2 – 12.9 mm	10 mm ²	10 mm ²
GT1141LPLUS	165766	GT (ONE SHOT)	1/2"	11.2 – 12.9 mm		16 mm ²
GT1141VPLUS	165767	GT (ONE SHOT)	1/2"	11.2 – 12.9 mm	50 mm ²	25 mm ² , 35 mm ²
GT1142GPLUS	-	GT (ONE SHOT)	1/2"	11.2 – 12.9 mm	70 mm ²	70 mm ²
GT1161GPLUS	165768	GT (ONE SHOT)	5/8"	14.1 – 16.1 mm	10 mm ²	10 mm ²
GT1161LPLUS	165769	GT (ONE SHOT)	5/8"	14.1 – 16.1 mm		16 mm ²

Part Number	Article Number	Mold Family	Ground Rod Diameter, Nominal	Ground Rod Diameter, Actual	Connection, Solid	Connection, Stranded
GT1161VPLUS	165770	GT (ONE SHOT)	5/8"	14.1 – 16.1 mm	50 mm ²	25 mm ² , 35 mm ²
GT1162CPLUS	165771	GT (ONE SHOT)	5/8"	14.1 – 16.1 mm		50 mm ²
GT1162GPLUS	165772	GT (ONE SHOT)	5/8"	14.1 – 16.1 mm	70 mm ²	70 mm ²
GT1181GPLUS	165773	GT (ONE SHOT)	3/4"	17.1 – 19.4 mm	10 mm ²	10 mm ²
GT1181LPLUS	165774	GT (ONE SHOT)	3/4"	17.1 – 19.4 mm		16 mm ²
GT1181VPLUS	165775	GT (ONE SHOT)	3/4"	17.1 – 19.4 mm	50 mm ²	25 mm ² , 35 mm ²
GT1182CPLUS	165776	GT (ONE SHOT)	3/4"	17.1 – 19.4 mm		50 mm ²
GT1182GPLUS	-	GT (ONE SHOT)	3/4"	17.1 – 19.4 mm	70 mm ²	70 mm ²
NT1141GPLUS	165777	NT (ONE SHOT)	1/2"	11.2 – 12.9 mm	10 mm ²	10 mm ²
NT1141LPLUS	165778	NT (ONE SHOT)	1/2"	11.2 – 12.9 mm		16 mm ²
NT1141VPLUS	165779	NT (ONE SHOT)	1/2"	11.2 – 12.9 mm	50 mm ²	25 mm ² , 35 mm ²
NT1161G1TPLUS	-	NT (ONE SHOT)	5/8"	14.1 – 16.1 mm		10 mm ²
NT1161GPLUS	165780	NT (ONE SHOT)	5/8"	14.1 – 16.1 mm	10 mm ²	10 mm ²
NT1161LPLUS	165781	NT (ONE SHOT)	5/8"	14.1 – 16.1 mm		16 mm ²
NT1161VPLUS	165782	NT (ONE SHOT)	5/8"	14.1 – 16.1 mm	50 mm ²	25 mm ² , 35 mm ²
NT1181GPLUS	165783	NT (ONE SHOT)	3/4"	17.1 – 19.4 mm	10 mm ²	10 mm ²
NT1181LPLUS	165784	NT (ONE SHOT)	3/4"	17.1 – 19.4 mm		16 mm ²
NT1181VPLUS	165785	NT (ONE SHOT)	3/4"	17.1 – 19.4 mm	50 mm ²	25 mm ² , 35 mm ²
NX1141GPLUS	165786	NX (ONE SHOT)	1/2"	11.2 – 12.9 mm	10 mm ²	10 mm ²
NX1141LPLUS	165787	NX (ONE SHOT)	1/2"	11.2 – 12.9 mm		16 mm ²
NX1161G1TPLUS	-	NX (ONE SHOT)	5/8"	14.1 – 16.1 mm		10 mm ²
NX1161GPLUS	165788	NX (ONE SHOT)	5/8"	14.1 – 16.1 mm	10 mm ²	10 mm ²
NX1161LPLUS	165789	NX (ONE SHOT)	5/8"	14.1 – 16.1 mm		16 mm ²
NX1161VPLUS	165790	NX (ONE SHOT)	5/8"	14.1 – 16.1 mm	50 mm ²	25 mm ² , 35 mm ²
NX1181GPLUS	165791	NX (ONE SHOT)	3/4"	17.1 – 19.4 mm	10 mm ²	10 mm ²
NX1181LPLUS	165792	NX (ONE SHOT)	3/4"	17.1 – 19.4 mm		16 mm ²
NX1181VPLUS	165793	NX (ONE SHOT)	3/4"	17.1 – 19.4 mm	50 mm ²	25 mm ² , 35 mm ²
Welding Material Type: Traditional						
GR1141G	-	GR (ONE SHOT)	1/2"	11.2 – 12.9 mm	10 mm ²	10 mm ²
GR1141L	-	GR (ONE SHOT)	1/2"	11.2 – 12.9 mm		16 mm ²
GR1141V	-	GR (ONE SHOT)	1/2"	11.2 – 12.9 mm	50 mm ²	25 mm ² , 35 mm ²
GR1161G	-	GR (ONE SHOT)	5/8"	14.1 – 16.1 mm	10 mm ²	10 mm ²
GR1161GF	-	GR (ONE SHOT)	5/8"	14.1 – 16.1 mm	10 mm ²	10 mm ²
GR1161L	-	GR (ONE SHOT)	5/8"	14.1 – 16.1 mm		16 mm ²
GR1161V	-	GR (ONE SHOT)	5/8"	14.1 – 16.1 mm	50 mm ²	25 mm ² , 35 mm ²
GR1162C	-	GR (ONE SHOT)	5/8"	14.1 – 16.1 mm		50 mm ²
GR1162G	-	GR (ONE SHOT)	5/8"	14.1 – 16.1 mm	70 mm ²	70 mm ²
GR1162Q	-	GR (ONE SHOT)	5/8"	14.1 – 16.1 mm		95 mm ²
GR1181G	-	GR (ONE SHOT)	3/4"	17.1 – 19.4 mm	10 mm ²	10 mm ²
GR1181L	-	GR (ONE SHOT)	3/4"	17.1 – 19.4 mm		16 mm ²
GR1181V	-	GR (ONE SHOT)	3/4"	17.1 – 19.4 mm	50 mm ²	25 mm ² , 35 mm ²
GR1182C	-	GR (ONE SHOT)	3/4"	17.1 – 19.4 mm		50 mm ²
GR1182G	-	GR (ONE SHOT)	3/4"	17.1 – 19.4 mm	70 mm ²	70 mm ²
GR1182Q	-	GR (ONE SHOT)	3/4"	17.1 – 19.4 mm		95 mm ²
GT1141G	-	GT (ONE SHOT)	1/2"	11.2 – 12.9 mm	10 mm ²	10 mm ²
GT1141L	-	GT (ONE SHOT)	1/2"	11.2 – 12.9 mm		16 mm ²
GT1141V	-	GT (ONE SHOT)	1/2"	11.2 – 12.9 mm	50 mm ²	25 mm ² , 35 mm ²
GT1161G	-	GT (ONE SHOT)	5/8"	14.1 – 16.1 mm	10 mm ²	10 mm ²
GT1161L	-	GT (ONE SHOT)	5/8"	14.1 – 16.1 mm		16 mm ²
GT1161LF	-	GT (ONE SHOT)	5/8"	14.1 – 16.1 mm		16 mm ²
GT1161V	-	GT (ONE SHOT)	5/8"	14.1 – 16.1 mm	50 mm ²	25 mm ² , 35 mm ²
GT1161VF	-	GT (ONE SHOT)	5/8"	15.6 – 16.1 mm	50 mm ²	25 mm ² , 35 mm ²
GT1162C	-	GT (ONE SHOT)	5/8"	14.1 – 16.1 mm		50 mm ²
GT1162G	-	GT (ONE SHOT)	5/8"	14.1 – 16.1 mm	70 mm ²	70 mm ²
GT1181G	-	GT (ONE SHOT)	3/4"	17.1 – 19.4 mm	10 mm ²	10 mm ²

Part Number	Article Number	Mold Family	Ground Rod Diameter, Nominal	Ground Rod Diameter, Actual	Connection, Solid	Connection, Stranded
GT1181L	-	GT (ONE SHOT)	3/4"	17.1 – 19.4 mm		16 mm ²
GT1181V	-	GT (ONE SHOT)	3/4"	17.1 – 19.4 mm	50 mm ²	25 mm ² , 35 mm ²
GT1182C	-	GT (ONE SHOT)	3/4"	17.1 – 19.4 mm		50 mm ²
GT1182G	-	GT (ONE SHOT)	3/4"	17.1 – 19.4 mm	70 mm ²	70 mm ²
NT1141G	-	NT (ONE SHOT)	1/2"	11.2 – 12.9 mm	10 mm ²	10 mm ²
NT1141L	-	NT (ONE SHOT)	1/2"	11.2 – 12.9 mm		16 mm ²
NT1141V	-	NT (ONE SHOT)	1/2"	11.2 – 12.9 mm	50 mm ²	25 mm ² , 35 mm ²
NT1161G	-	NT (ONE SHOT)	5/8"	14.1 – 16.1 mm	10 mm ²	10 mm ²
NT1161L	-	NT (ONE SHOT)	5/8"	14.1 – 16.1 mm		16 mm ²
NT1161V	-	NT (ONE SHOT)	5/8"	14.1 – 16.1 mm	50 mm ²	25 mm ² , 35 mm ²
NT1181G	-	NT (ONE SHOT)	3/4"	17.1 – 19.4 mm	10 mm ²	10 mm ²
NT1181L	-	NT (ONE SHOT)	3/4"	17.1 – 19.4 mm		16 mm ²
NT1181V	-	NT (ONE SHOT)	3/4"	17.1 – 19.4 mm	50 mm ²	25 mm ² , 35 mm ²
NX1141G	-	NX (ONE SHOT)	1/2"	11.2 – 12.9 mm	10 mm ²	10 mm ²
NX1141L	-	NX (ONE SHOT)	1/2"	11.2 – 12.9 mm		16 mm ²
NX1161G	-	NX (ONE SHOT)	5/8"	14.1 – 16.1 mm	10 mm ²	10 mm ²
NX1161G1T	-	NX (ONE SHOT)	5/8"	14.1 – 16.1 mm		10 mm ²
NX1161L	-	NX (ONE SHOT)	5/8"	14.1 – 16.1 mm		16 mm ²
NX1161V	-	NX (ONE SHOT)	5/8"	14.1 – 16.1 mm	50 mm ²	25 mm ² , 35 mm ²
NX1181G	-	NX (ONE SHOT)	3/4"	17.1 – 19.4 mm	10 mm ²	10 mm ²
NX1181L	-	NX (ONE SHOT)	3/4"	17.1 – 19.4 mm		16 mm ²
NX1181V	-	NX (ONE SHOT)	3/4"	17.1 – 19.4 mm	50 mm ²	25 mm ² , 35 mm ²

A gap between conductors may be required. See mold tag for more information.

nVent ERICO Cadweld One Shot



PERMANENT EXOTHERMIC CONNECTIONS WITHOUT THE MOLD

Cadweld One Shot produces a permanent exothermic connection to a ground rod that will not loosen, corrode or increase in resistance for the life of the installation. The convenient single-use package makes the connection to the ground rod without a mold or starting material.

Thanks to the electronic Cadweld One Shot Control Unit, welds can now be completed up to 6 ft. (1.8 m) away, increasing weld flexibility in hard-to reach areas. The refractory ceramic body on the Cadweld One Shot is more durable than conventional ceramic and resists breaking.

INSTALLATION IS EASY!



1. After preparing the ground rod and wire, position the Cadweld One Shot and attach the lead to the control unit.



2. Ignite the Cadweld One Shot with the electronic Cadweld Plus Control Unit.



3. After one minute, break off the ceramic crucible. It can also be left in place, if desired.

FEATURES

- Easy-to-use electronic ignition. No starting material needed
- Extremely durable disposable ceramic outer body eliminates the graphite mold and frame
- Produces a permanent connection that will not loosen or corrode
- Fits both plain and threaded copper-bonded and full-size steel and stainless steel ground rods
- NEC® compliant
- cULus® Listed

nVent ERICO Cadweld Multi



CADWELD MULTI

The complete welding system for improving grounding system performance, reliability, and installation convenience.

Cadweld Multi simplifies the exothermic welding process. Make over 30 separate connection types with a single, universal mold, which now enables you to make connections to a ground rod.

Welding material sold separately.



EXOTHERMIC WELDED CONNECTIONS

Exothermic welded connections are immune to thermal conditions which can cause mechanical and compression joints to become loose or corrode. They are recognized for their durability and longevity.

CADWELD MULTI OFFERS ENHANCED USER BENEFITS:

- Performs welds to ground rods
- Versatile mold produces an unlimited variety of connections
- Compact compression structure enables easy alignment of conductors
- Language-free instruction guide
- Lightweight kit for easy transportation
- Easy-to-use system completes weld in seconds
- Video available on nVent.com/ERICO



CADWELD CONNECTION

The Cadweld Plus exothermic welding process fuses conductors together to form a molecular bond with a current-carrying capacity equal to that of the conductor. Grounding systems incorporating this type of connection therefore operate as a continuous conductor with lower resistivity.

STANDARD COMPLIANCE

Cadweld Multi satisfies the requirements of:

- BS 6651
- BS 7430
- NFC 15-100
- IEEE® 837-2014
- IEEE 80-2000
- IEC 1025-1 (ENV 61024-1)

nVent ERICO Cadweld Multi

4 EASY STEPS FOR MULTIPLE, PERMANENTLY WELDED, ELECTRICAL CONNECTIONS

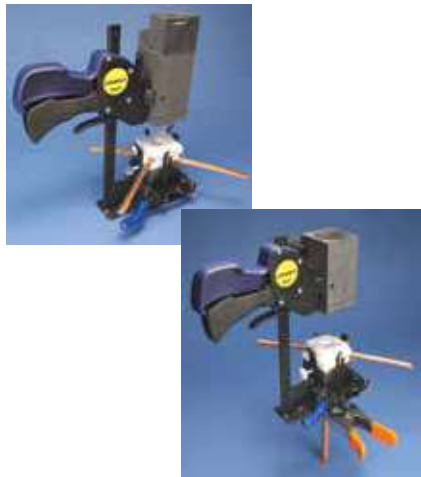

Step 1: Layer batting and variable conductor sizes to be welded into dry mold.

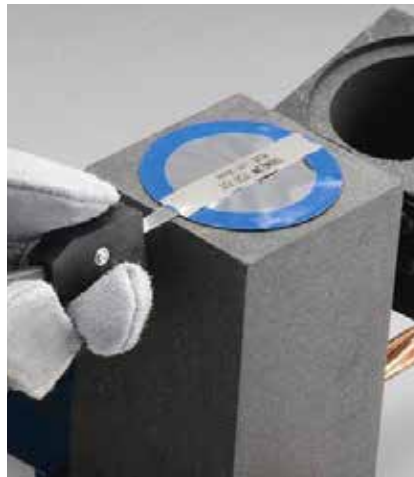

Step 2: Add Cadweld Plus welding material.



Step 3: Close cover and connect Cadweld Plus control unit.



Step 4: Press and hold operate button. Open mold after 10 seconds.

HOW DOES IT WORK?

Cadweld Multi combines a versatile mold block and a range of gaskets (batting) to allow numerous different welded connections to be produced without the need to change the mold for each connection type



The process is similar to the Cadweld with one distinct difference...

there is no need to change the mold for different connection types.

The whole process is complete in about one minute. Page 31 details the gasket quantities required for each weld.

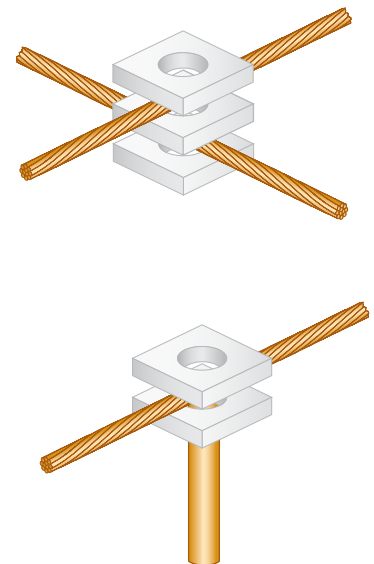

nVent ERICO Cadweld Multi

CADWELD MULTI OFFERS ALL OF THE BENEFITS OF CADWELD CONNECTIONS:

- Current-carrying capacity equal to that of the conductor
- Permanent molecular bond that will not loosen or corrode
- Works with Cadweld traditional welding material
- Works with Cadweld Plus welding material
- Will withstand repeated fault currents
- No external power or heat required
- Ground rod capabilities
- Visual inspection possible
- Requires minimal training

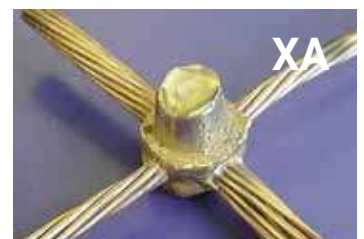

nVent ERICO Cadweld Multi

CADWELD MULTI CONNECTION CAPABILITIES

Copper Cable/Solid to Copper Cable/Solid

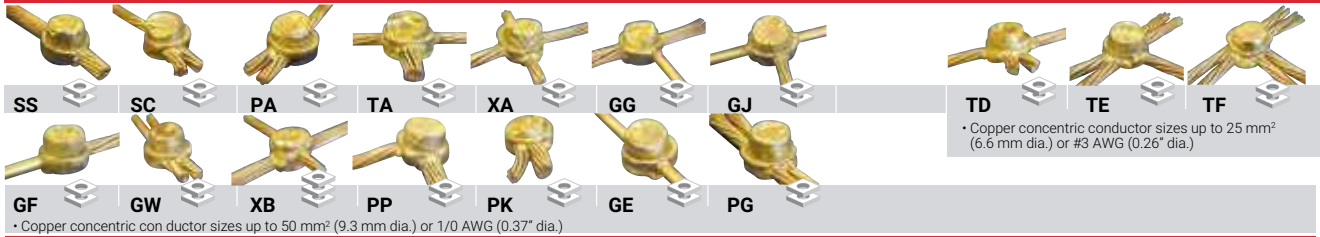

Copper Cable/Solid Strip to Rebar

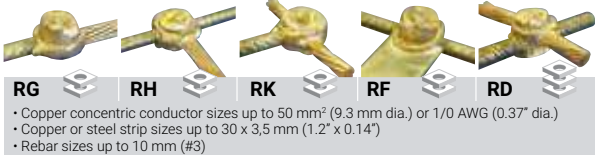

Copper Strip to Copper Strip

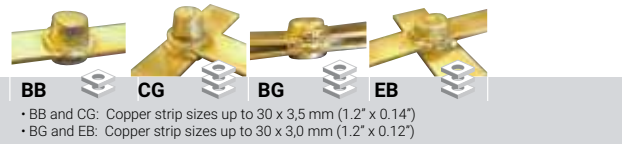

Copper Cable/Solid to Copper or Steel Strip/Lug

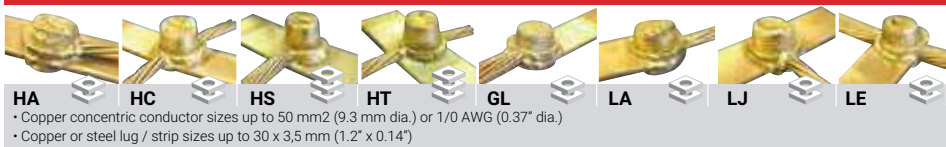

Galvanized Steel Strip to Galvanized Steel Strip



Ground Rod Connections

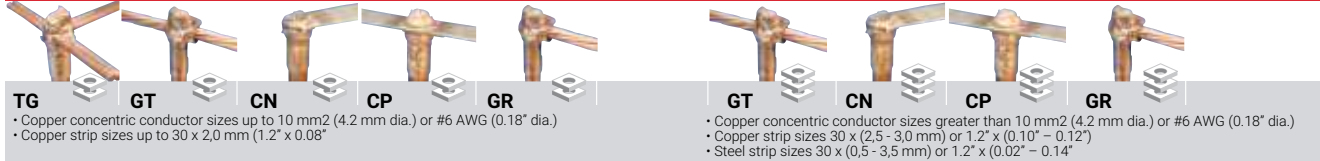

Cadweld Multi Available Items

Part Nr	Article Nr	Description	Weight (kg)
KITCDMV01	167782	Cadweld Multi Kit	25.000
The Cadweld Multi kit (KITCDMV01) contains the following list of items:			
FMCDMV01	120883	Handle Clamp	1.800
CDMV01H	240399	Mold for H welds	1.200
CDMV0112	240398	Mold for welds on 1/2 rods	1.200
CDMV0158	240397	Mold for welds on 5/8 rods	1.200
CDMV0134	240396	Mold for welds on 3/4 rods*	1.200
SCDM01	120886	Set of 33 batting/gaskets	0.200
B399P	162070	SKK1 clamp	0.500
TSCSTP	197295	Toolset	2.000
B136B	182030	Slag Removal Spade	0.144
		Language free instruction sheet	1
The following items can be used with the Cadweld Multi Kit (KITCDMV01). They are sold separately.			
T320	165000	Flint Ignitor T320	0.090
90	163040	10	0.090
115	163050	10	0.115
PLUSCU	165745	Control Unit	1.088
PLUS#90F20	165705	Cadweld Plus welding material	0.158

Symbol denotes number of batting (gaskets) required for each connection.

Requires 2 batting layers for weld
Requires 3 batting layers for weld

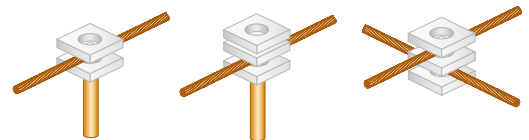

NOTES:

- *For connections using a 3/4" ground rod, it is necessary to use #115 / 115PLUSF20 weld material (sold separately).
- For all other connection types, use #90 or 90PLUSF20.
- For connections using galvanized material, remove galvanizing before welding, for a better connection.

nVENT ERICO CADWELD ONE SHOT, CABLE TO CABLE

FEATURE

- Single use ceramic mold which eliminates the need for a graphite mold and handle clamp/frame
- Produces a permanent connection that will not loosen or corrode
- NEC® compliant

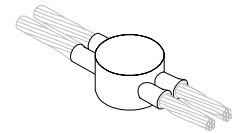

Part Number	Mold Family	Connection, Solid	Connection, Stranded
Welding Material Type: nVent ERICO Cadweld Plus			
PG11LPLUS	PG (ONE SHOT)		16 mm ²
Welding Material Type: Traditional			
PG11L	PG (ONE SHOT)		16 mm ²
PG11V	PG (ONE SHOT)	50 mm ²	25 mm ² , 35 mm ²

1 HOLE LUG

FEATURE

- Provides an efficient bolting surface for grounding and power applications
- Electrolytic grade copper
- For use with nVent ERICO Cadweld type LA connections only



Material: Copper
Finish: Tinned
Type: Non-NEMA®

Part Number	Article Number	Length	Width	Thickness	A	Hole Size	Equivalent Conductor Size
KA102	183010	49.987 mm	24.994 mm	2.01 mm	12 mm	8.50 mm	50 mm ²
KA103	183020	49.987 mm	24.994 mm	3.00 mm	12 mm	8.50 mm	75 mm ²
KA115	183140	94.996 mm	49.987 mm	5.99 mm	25 mm	10.49 mm	300 mm ²

For sizes not listed, contact us.

1 HOLE OFFSET LUG

FEATURE

- Provides an efficient bolting surface for grounding and power applications
- Electrolytic grade copper
- For use with nVent ERICO Cadweld type LA connections only

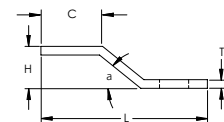

Part Number	Article Number	H	L	W	T	A	B	C	HS	a
Material: Copper – Finish: Tinned Type – NEMA®:										
B101CEOL	–	15.88	63.500	25.400	3.18	12.7	25.4	22.2	11.11	45
B101DEOL	–	17.53	68.326	25.400	4.76	14.3	28.6	22.2	14.29	45

Part Number	Article Number	H	L	W	T	A	B	C	HS	a
B101EEOL	-	19.05	76.200	25.400	6.35	15.9	32.5	26.9	14.29	45
Material: Copper – Finish: Tinned Type – Non-NEMA®:										
B305TC	-	20.00	91.400	30.000	5.00	15.0	33.8	39.9	17.00	45
KOF103	183200	13.00	54.999	24.994	3.00	10.0	20.0	25.0	8.50	45
Material: Stainless Steel 304 (EN 1.4301) – Type: Non-NEMA®										
B305SS	-	20.07	91.440	29.972	5.08	15.0	33.8	39.9	17.00	45

For sizes not listed, contact us.

2 HOLE OFFSET LUG

FEATURE

- Provides an efficient bolting surface for grounding and power applications
- Electrolytic grade copper
- For use with nVent ERICO Cadweld type LA connections only

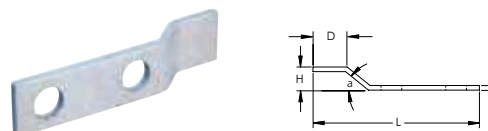

Material: Copper
Finish: Tinned
Type: NEMA®

Part Number	H	L	W	T	A	B	C	D	HS
B102CEOL	15.88	114.300	25.400	3.18	15.9	44.5	76.2	22.2	14.29
B102EEOL	19.05	120.650	25.400	6.35	15.9	44.5	76.2	26.9	14.29

For sizes not listed, contact us.

1 HOLE LUG, GL STYLE

FEATURE

- Provides an efficient bolting surface for grounding and power applications
- Electrolytic grade copper
- For use with nVent ERICO Cadweld type GL connections only

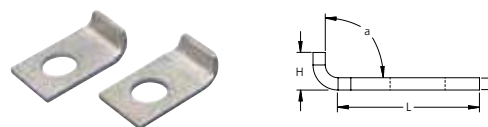

Material: Copper
Finish: Tinned
Type: NEMA®

Part Number	Article Number	Height	Length	Width	Thickness	A	Hole Size	Angle	Equivalent Conductor Size
B121CE	183650	11.18 mm	36.576 mm	25.400 mm	3.18 mm	15.9 mm	14.29 mm	90°	81 mm ²
B121DE	-	11.18 mm	37.338 mm	25.400 mm	4.76 mm	15.9 mm	14.29 mm	105°	121 mm ²

For sizes not listed, contact us.

2 HOLE LUG, GL STYLE

FEATURE

- Provides an efficient bolting surface for grounding and power applications
- Electrolytic grade copper
- For use with nVent ERICO Cadweld type GL connections only

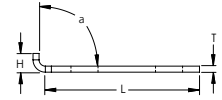

Material: Copper
 Finish: Tinned
 Type: NEMA®

Part Number	Article Number	H	L	W	T	A	B	HS	a	Equivalent Conductor Size
B122CE	183660	11.18	81.026	25.400	3.18	15.9	44.5	14.29	90	81
B122DE	-	11.18	82.550	25.400	4.76	15.9	44.5	14.29	90	121

For sizes not listed, contact us.

HANDLE CLAMP FOR THREE-PIECE VERTICAL SPLIT MOLDS

FEATURE

- Opens the mold in two directions
- Provides more convenience and further simplifies the installation process



Part Number	Price Key
L163	3
L164	4

HANDLE CLAMP, MAGNETIC

FEATURE

- Designed to securely hold an nVent ERICO Cadweld mold to a large flat or slightly curved vertical steel surface
- Used on vertically split molds



Part Number	Article Number	Price Key
B159M	161631	D, F
B396	161632	C, R

HANDLE CLAMP WITH CHAIN SUPPORT

FEATURE

- Securely holds the nVent ERICO Cadweld mold to a pipe
- See specific nVent ERICO Cadweld mold requirements



Part Number	Article Number	Price Key	Connection Type
Pipe Orientation: Horizontal			
B160H	-	C, R	HA, HC, HS, HT
Pipe Orientation: Vertical			
B159V	-	D, F	VS, VF, VB, VV
B160V	-	C, R	VS, VF, VB, VV
L160VG	161660	C, R	VG

HANDLE CLAMP CHAIN

FEATURE

- Handle clamp accessory used on specific clamps to securely hold the nVent ERICO Cadweld mold to a pipe
- See specific nVent ERICO Cadweld mold requirements



Part Number	Mold Family	Handle Clamp	Chain Length	Pipe Orientation	Pipe Size
B158	HA, HC, HS, HT, VB	B159V, B160V, B159VT, B160VT, B159H, and B160H	508 mm	Horizontal, Vertical	4" – 10"

MAGNETIC ASSEMBLY

FEATURE

- Powerful welding magnet securely positions the mold during the connection process to a flat steel surface or steel pipe
- Helps with mold stability to reduce the chance of welding material leakage
- Quickly and easily attaches to hold down "A" Price Key molds (new or retrofit)
- Assembly is adjustable
- Ideal when used with nVent ERICO Cadweld Plus to allow for use of full extension of control unit lead



Part Number	Article Number
B323N2	161630

SUPPORT CLAMP FOR VERTICAL FLAT STEEL SURFACE

FEATURE

- Securely supports an nVent ERICO Cadweld mold to a vertical "H" column or angle
- Easily attaches to an L160 or L159 handle clamp
- For use with type VF molds for up to 3/4" (19.1 mm) thick steel
- For use with type VB, VG, VN, and VS molds for up to 1" (25.4 mm) thick steel

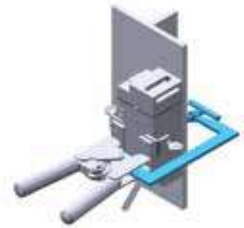

Part Number	Article Number	Handle Clamp
	161740	L160, Sold Separately
	161780	L159, Sold Separately

FENCE FABRIC ATTACHMENT ASSEMBLY

FEATURE

- Fastens to an L160 or L159 handle clamp
- Firmly holds the mold to the fence post after the fence fabric is in place
- Ideal for retrofit jobs



Part Number	Article Number	Connection Type
	161635	VS, VF, VB, VV

HANDLE CLAMP, MINI EZ

FEATURE

- Mini EZ Handle Clamps are typically included with the mold
- See specific nVent ERICO Cadweld mold or nVent ERICO Cadweld kit requirements to determine the handle clamp requirements



Part Number	Article Number	Price Key
B399A	-	N, P, T
B399B	-	N, P, T
B399Q	161080	N, P, T
L161	161010	N, P, T

HANDLE CLAMP, MINI EZ WITH CHAIN SUPPORT

FEATURE

- Securely holds the nVent ERICO Cadweld mold to a rod or rebar in a vertical position



Part Number	Article Number	Price Key	Connection Type
L161A	161090	P	GYP, GY35 Compact kit, RC35 and GY35 Maxikit

HANDLE CLAMP, MINI EZ, MAGNETIC

FEATURE

- Designed to securely hold an nVent ERICO Cadweld mold to a large flat or slightly curved vertical steel surface
- Allows for simple placement of the nVent ERICO Cadweld mold in the desired connection location
- See specific nVent ERICO Cadweld mold or nVent ERICO Cadweld kit requirements to determine the handle clamp requirements



Part Number	Article Number	Price Key	Mold Size
B399AM	161633	N, P, T	38.1 mm
B399BM	161634	N, P, T	51 mm

CABLE CLAMP ASSEMBLY

FEATURE

- Designed for use with hard-drawn copper cable, copper-bonded conductors or any cable under tension
- Use of the clamp aids in preventing cable movement and prolongs mold life



Part Number	Article Number
B265	165020

GROUND ROD CLAMPING TOOL

FEATURE

- Must be used to provide the correct positioning of ground rods and mold while splicing the rods with nVent ERICO Cadweld for HDGB and GB type connections



Part Number	Article Number
B120	161750

DISK

FEATURE

- Required each time a traditional nVent ERICO Cadweld connection is made
- Placed at the bottom of the crucible, holding the welding material until the reaction takes place



Material: Steel

Part Number	Article Number	Welding Material	Diameter
B117A	141154	15 - 32, Sold Separately	19.1 mm
B117B	141156	45 - 115, Sold Separately	25.4 mm
B117C	141157	150 - 500, Sold Separately	38.1 mm

DISK KIT

FEATURE

- Contains three disk sizes for common nVent ERICO Cadweld connection applications
- Convenience item for replacing lost or damaged disks



Part Number	Material
T328D	Steel

CONDUCTOR SLEEVE

FEATURE

- Used to adapt a limited range of smaller size cables to a larger size nVent ERICO Cadweld Mold
- Provides strength and stability on finely-stranded copper conductors

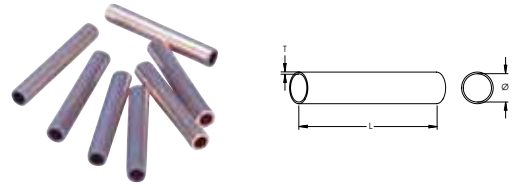

Material: Copper
Finish: Tinned

Part Number	Article Number	Length	Thickness	Diameter
Type: Flared				
180380	180380	25.000 mm	2.40 mm	5.3 mm
H102F	180390	26.000 mm	1.05 mm	4.3 mm
H106AF	180260	35.000 mm	1.00 mm	15.0 mm
H106F	180250	26.000 mm	1.00 mm	15.0 mm
H113F	180360	26.000 mm	1.00 mm	8.0 mm
H11F	180320	26.000 mm	1.00 mm	13.0 mm
PBS24F	-	38.100 mm	0.79 mm	20.2 mm
S02F	-	25.400 mm	0.79 mm	15.5 mm
S03F	-	25.400 mm	0.79 mm	11.6 mm
S05F	-	25.400 mm	0.79 mm	9.9 mm
S07F	-	25.400 mm	0.79 mm	17.0 mm
S17F	-	25.400 mm	0.79 mm	8.7 mm
S429F2J16	-	25.400 mm	0.51 mm	12.2 mm
S429F2N16	-	25.400 mm	0.51 mm	13.7 mm
S429F3S20	-	31.750 mm	0.64 mm	23.6 mm
Type: Straight				
B112	-	26.988 mm	0.79 mm	5.4 mm
B1331K	-	25.400 mm	0.79 mm	3.6 mm
H101	180140	26.000 mm	1.00 mm	6.0 mm
H102	180170	25.000 mm	1.05 mm	4.3 mm
H103	180180	25.000 mm	1.20 mm	5.3 mm
H105	180230	23.500 mm	1.00 mm	3.0 mm
H117	180430	25.000 mm	1.00 mm	7.0 mm

SLEEVE KIT

FEATURE

- Contains a variety of adapter sleeves that allow a buildup of smaller conductors to fit the opening of larger sized conductors in a nVent ERICO Cadweld mold
- Includes shim stock for wrapping around a conductor, increasing the diameter to fit larger conductor openings in a nVent ERICO Cadweld mold
- Contains extra disks for all sizes of traditional welding material
- Includes extra flints for nVent ERICO Cadweld Flint Igniters

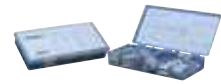

Part Number	Article Number
T427	162423

COPPER SHIM

FEATURE

- Wrapped around the cable until the diameter is about the same as the cable opening in the mold

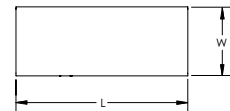

Material: Copper

Part Number	Article Number	Length	Width	Thickness
B140A	-	38.100 mm	76.200 mm	0.33 mm
B140N	165610	76.200 mm	38.100 mm	0.33 mm
B141A	-	38.100 mm	76.200 mm	0.33 mm

BATTING/PACKING MATERIAL

FEATURE

- Preformed ceramic packing material
- Seals mold conductor openings
- Prevents welding material leakage
- See nVent ERICO Cadweld mold requirements for specific batting part number



Part Number	Article Number
B144B	-
B144C	-
B144M	159790
B144Q	159780

Part Number	Article Number
S2904A	185010
S2904B	185020
S2904C	185030

GALVANIZING BAR

FEATURE

- Used to repair a galvanized surface that has been damaged by welding or drilling
- Low-temperature self-fluxing material
- The bar may be melted using the heat produced after making a nVent ERICO Cadweld connection, or a small torch may be used



Part Number	Article Number	Material
T319	162426	Zinc Alloy

GALVANIZING SPRAY

FEATURE

- Easy-to-use galvanizing paint in a spray can
- Used to touch up heat affected areas on galvanized steel surfaces after welding



Part Number	Unit Weight
T372A	453 g

HAMMER DIE

FEATURE

- Hardened steel die
- Used to form the end of a field-made bond
- Formed end designed to fit specific nVent ERICO Cadweld mold



Material: Steel

Part Number	Article Number	Conductor Size	nVent ERICO Sleeve
Type: Power			
PBWD102	184200	120 mm ² Concentric	H106F
PBWD106	184090	240 mm ² Concentric	S429FY922

Part Number	Article Number	Conductor Size	nVent ERICO Sleeve
Type: Signal			
SBD50	-	3/16" Bondstrand	SBS12C
SBD51	-	5/16" Bondstrand	SBS09C
SBD55	-	35 mm ² Concentric	S17F

MOLD SEALER

FEATURE

- Ideal for sealing hot or cold molds to retard leakage from large stranded conductors
- Prolongs useful mold life when the cable opening becomes worn
- Required on certain nVent ERICO Cadweld molds such as Types HA, HB, HC, VG and VN



Part Number	Article Number	Unit Weight
T403	165280	0.907 kg

NVENT ERICO CADWELD PLUS CONTROL UNIT

FEATURE

- Battery-powered controller box designed for 600 connections with one set of batteries
- Requires no special batteries or charger
- Comes standard with high temperature lead
- Connects to the welding material ignition strip with a custom made, purpose-designed termination clip
- Sends a predetermined voltage to the ignition strip and initiates the reaction
- The PBPLUSCU control unit electronic ignitor is primarily designed for ignition of nVent ERICO Cadweld Plus WELDING MATERIAL, F80
- PBPLUSCU meets AREMA[®] C&S Manual Recommendations; Part 8.1.34, 2013



Part Number	Article Number	Cable Length	Batteries	Working Temperature	Certifications
PBPLUSCU	-	1.8 m	8 Lithium AA Batteries	-40 to 60 °C	CE, ERICO PLUSCU, cURus, NOM
PLUSCU	165738	1.8 m	8 Standard AA Batteries	-18 to 55 °C	CE, ERICO PLUSCU, cURus

All nVent ERICO Cadweld Plus connections on rail properties must be installed using nVent ERICO Cadweld Plus Welding Material, F80.

FLINT IGNITOR

FEATURE

- Used to ignite the starting material when making a traditional nVent ERICO Cadweld connection or a nVent LENTON Cadweld rebar connection



Part Number	Article Number
T320	165000

REPLACEMENT FLINT

FEATURE

- Replacement flints for T320 Flint Ignitor



Part Number	Article Number	Standard Packaging Quantity
T320A	165010	10 pc

FLINT IGNITOR EXTENSION

FEATURE

- Attaches to T320 Flint Ignitor and allows the installer to be approximately 30" (762 mm) away from the mold
- Ideal for applications such as making a mold in a narrow trench while the installer is at ground level



Part Number	Article Number
B32130	162429

BATTERY PACK

FEATURE

- Battery, charger, and carrying case required for the ignition of nVent ERICO Cadweld Exolon welding material
- Battery operates approximately 200 connections before requiring a recharge
- Charger, all electrical connections and instructions are included in the battery case



Part Number
XLB971A1

TORCH HEAD

FEATURE

- Self-igniting propane torch head
- Squeezing the control knob produces an instant flame; releasing it extinguishes the flame
- No flame adjusting
- Burn tip remains cool during normal use
- Operates on its side or upside down
- Can withstand 60 MPH (96 KPH) winds without flareout
- Fits all standard 14.1 and 16.4 ounce (400 and 465 gram) propane cylinders



Part Number	Article Number
T111	165170

CARD CLOTH BRUSH

FEATURE

- Aids in removing oxides from conductor surfaces
- Made of short, stiff bristles
- Generally preferred for cleaning concentric conductors and busbars which are not heavily oxidized



Part Number	Article Number
T313	165040

WIRE BRUSH

FEATURE

- Aids in removing oxides from conductor surfaces
- Useful for cleaning coarse or very dirty conductors



Part Number	Article Number	Product
T314	165130	Brush with Replaceable Brush Heads
T314A	165270	Replacement Brush Heads

MOLD CLEANING BRUSH

FEATURE

- Ideal for cleaning nVent ERICO Cadweld molds
- Soft bristles minimize wear of graphite during the cleaning process
- Removes slag and particles from mold cavity, tap hole, crucible and cover



Part Number	Article Number	Type
T302A	165260	Wide
T394	162427	Narrow

MOLD CLEANER

FEATURE

- Used to remove the slag from the crucible area of the mold after making a nVent ERICO Cadweld connection



Part Number	Article Number	Mold Type
B136A	182125	Most nVent ERICO Cadweld molds using #65 welding material and smaller
B136B	182130	Most nVent ERICO Cadweld molds using #90 welding material and larger
B136F	182135	Specific nVent ERICO Cadweld molds only (See mold requirements to determine need)

RASP

FEATURE

- Used to remove rust from steel surfaces or to remove galvanizing from hot dipped galvanized steel to expose the bare steel for welding
- Curved blade makes it an efficient tool for flat surfaces



Part Number	Article Number	Product
T321	162630	Rasp
T321A	162430	Replacement Blade

CANVAS GLOVE WITH LEATHER PALM

FEATURE

- Heavy canvas gloves with leather palms



Part Number	Article Number
T378L	162422

As with all tasks, it is recommended that users consider safety first when making nVent ERICO Cadweld connections and wear appropriate safety equipment.

SAFETY GLASSES

FEATURE

- Provides protection against moderate impact hazards
- May be worn separately or over prescription glasses



Material: Polycarbonate

Part Number	Article Number
T393	162421

As with all tasks, it is recommended that users consider safety first when making nVent ERICO Cadweld connections and wear appropriate safety equipment.

DISK CONTAINER

FEATURE

- Metal container for holding disks and small nVent ERICO Cadweld accessories



Part Number	Article Number	Diameter	Height
T328	162428	76.2 mm	25.4 mm

NVENT ERICO CADWELD TOOL KIT

FEATURE

- Convenient tool kits for nVent ERICO Cadweld connection installations



Part Number	Article Number	Product
T315A	162437	Complete Kit
T343	-	Heavy-Duty Kit

TOOL BOX

FEATURE

- Metal box with removable tote tray
- Recommended for carrying tools, molds, welding material and propane torch used to make nVent ERICO Cadweld connections



Part Number	Article Number	Length	Width	Height
T396	162436	482.6 mm	177.8 mm	190.5 mm

WELDING TRAY

FEATURE

- Recommended when using nVent ERICO Cadweld overhead or over expensive equipment
- Designed to contain a potential spill of molten weld metal

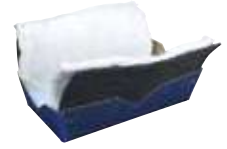

Part Number	Article Number	Height	Length	Width
XLB974B2	162435	82.55 mm	336.55 mm	177.8 mm

CERAMIC BLANKET

FEATURE

- Woven ceramic blanket that can be used to hold a hot mold or keep the work surface free of slag when cleaning the mold



Part Number	Article Number
T306	162431

Technical Charts

CONCENTRIC STRANDED CONDUCTOR SIZES

Size (AWG/MCM/mm ²)	Circular Mils	Stranding	Nominal O.D. of Strand	Approx. O.D. (inches)	Approx. O.D. (mm)	Weight (lbs/mft)	Cadweld Cable Code
8 AWG	16,510	Solid	–	0.1285	3.26	50.0	1D
8 AWG	16,510	7/.0486"	0.0486	0.1460	3.71	50.1	1E
6 AWG	26,240	Solid	–	0.1620	4.11	79.5	1G
6 AWG	26,240	7/.0612"	0.0612	0.1840	4.67	81.1	1H
16 mm ²	31,600	7/1.17	0.0461	0.2010	5.11	96.1	W3
4 AWG	41,740	Solid	–	0.2043	5.19	126.3	1K
4 AWG	41,740	7/.0772"	0.0772	0.2320	5.89	129.0	1L
4 AWG	41,740	19/.0469"	0.0469	0.2350	5.97	129.0	1L
25 mm ²	49,300	7/2.14 mm	0.0843	0.2530	6.43	152.5	Y1
25 mm ²	49,300	19/1.35	0.0531	0.2660	6.76	152.5	Y1
2 AWG	66,360	Solid	–	0.2576	6.54	200.9	1T
2 AWG	66,360	7/.0974"	0.0974	0.2920	7.42	204.9	1V
2 AWG	66,360	19/.0591"	0.0591	0.2920	7.42	205.0	1V
35 mm ²	66,360	19/1.53 mm	0.0602	0.3010	7.65	211.0	Y2
50 mm ²	98,500	19/1.78 mm	0.0701	0.3500	8.89	287.6	Y3
1/0 AWG	105,600	Solid	–	0.3249	8.25	319.5	2B
1/0 AWG	105,600	7/.1228"	0.1228	0.3690	9.37	326.0	2C
1/0 AWG	105,600	19/.0745"	0.0745	0.3730	9.47	326.0	2C
2/0 AWG	133,100	Solid	–	0.3648	9.27	402.8	2F
2/0 AWG	133,100	7/.1379"	0.1379	0.4140	10.52	410.9	2G
2/0 AWG	133,100	19/.0837"	0.0837	0.4190	10.64	410.9	2G
70 mm ²	138,000	19/2.14 mm	0.0843	0.4210	10.69	415.3	Y4
3/0 AWG	167,800	Solid	–	0.4096	10.40	507.8	2K
3/0 AWG	167,800	7/.1548"	0.1548	0.4650	11.81	518.0	2L
3/0 AWG	167,800	19/.0940"	0.0940	0.4700	11.94	518.0	2L
95 mm ²	187,000	37/1.78 mm	0.0700	0.4910	12.47	576.5	Y5
95 mm ²	187,000	19/2.52	0.0992	0.4960	12.60	576.5	Y5
4/0 AWG	211,600	Solid	–	0.4600	11.68	610.5	2P
4/0 AWG	211,600	7/.1739"	0.1739	0.5220	13.26	653.0	2Q
4/0 AWG	211,600	19/.1055"	0.1055	0.5280	13.41	653.0	2Q
120 mm ²	237,000	37/2.03 mm	0.0799	0.5600	14.22	737.1	Y6
250 MCM	250,000	19/.1147"	0.1147	0.5750	14.61	771.0	2V
250 MCM	250,000	37/.0822"	0.0822	0.5750	14.61	771.0	2V
150 mm ²	296,000	37/2.25 mm	0.0886	0.6200	15.75	896.4	Y7
300 MCM	300,000	19/.1257"	0.1257	0.6290	15.98	926.9	3A
300 MCM	300,000	37/.0900"	0.0900	0.6290	15.98	926.9	3A
185 mm ²	365,000	27/2.52 mm	0.0992	0.6950	17.65	1124.1	Y8
400 MCM	400,000	37/.1040	0.1040	0.7200	18.29	1235.2	3H
240 mm ²	474,000	61/2.25 mm	0.0886	0.7970	20.24	1478.2	Y9
500 MCM	500,000	19/.1622"	0.1622	0.8130	20.65	1544.0	3Q
500 MCM	500,000	37/.1162"	0.1162	0.8130	20.65	1544.0	3Q
750 MCM	750,000	61/.1109"	0.1109	0.9980	25.35	2316.0	4L
500 mm ²	987,000	61/3.20 mm	0.1260	1.1340	28.80	2990.8	W1
1000 MCM	1,000,000	61/.1280"	0.1280	1.1520	29.26	3088.0	4Y

DSA COPPER-CLAD CONDUCTOR

Cable Stranding	Nominal Diameter	kcmil	Equivalent Copper Size*	Cadweld Cable Code
7/#10	.306	72.7	3 AWG	9A
7/#8	.385	115.6	1	9B
7/#7	.433	145.7	1/0	9C
7/#6	.486	183.8	2/0	9D
7/#5	.546	231.7	3/0	9E
19/#9	.572	248.8	3/0	9F
7/#4	.613	292.2	4/0	9L
19/#8	.642	313.7	4/0	9G
19/#7	.721	395.5	250 Kcmil	9H
37/#9	.801	484.4	300	7W
19/#6	.810	498.8	350	9J
37/#8	.899	610.9	400	7V
19/#5	.910	628.9	450	9K
37/#7	1.010	770.3	500	9M

*Approximate based on fusing current calculations

RECTANGULAR COPPER BUSBAR

Thickness (inches)	Width (inches)	Circular Mil Size	Weight (lbs per foot)	Cadweld Busbar Code
1/8	1	159,200	.484	CE
	1-1/2	238,700	.726	CG
3/16	2	318,300	.969	CH
	1	238,700	.727	DE
	2	477,500	1.45	DH
	1	318,300	.969	EE
1/4	1-1/2	477,500	1.45	EG
	2	636,600	1.94	EH
	3	954,900	2.91	EK
	4	1,273,000	3.88	EM
	1	477,500	1.45	GE
3/8	1-1/2	716,200	2.18	GG
	2	954,900	2.91	GH
	3	1,432,000	4.36	GK
	4	1,910,000	5.81	GM
	2	1,273,000	3.88	JH
1/2	3	1,910,000	5.81	JK
	4	2,546,000	7.75	JM

GROUND RODS

Nominal Size	Material	Type	Thread Size	Body Dia.	Cadweld Ground Rod Code
1/2"	Copper-bonded	Threaded	9/16"	.505	14
	Steel*	Plain		.500	14
	Copper-bonded	Plain		.475	15
	Copper-bonded	Threaded	1/2"	.447	13
	Copper-bonded	Threaded	5/8"	.563	16
Steel*	Plain	.625		31	
Copper-bonded	Plain	.563		16	
5/8"	Copper-bonded	Threaded	3/4"	.682	18
	Steel*	Plain		.750	33
	Copper-bonded	Plain	1"	.682	18
	Copper-bonded	Threaded		.914	22
1"	Steel*	Plain	1"	1.000	37
	Copper-bonded	Plain		.914	22

*Plain steel, stainless steel, stainless clad rods or galvanized steel.

REINFORCING BARS

Rebar Sizes	Nominal Dimensions			
	Dia. (inches)	Cross-Sectional Area (Sq. inches)	Equivalent Copper Sizes*	Cadweld Rebar Code
3	.375	.11	9 AWG	51
4	.500	.20	7	52
5	.625	.31	5	53
6	.750	.44	3	54
7	.875	.60	2	55
8	1.000	.79	1	56
9	1.128	1.00	1/0	57
10	1.270	1.27	2/0	58
11	1.410	1.56	3/0	59
14	1.693	2.25	250 kcmil	60
18	2.257	4.00	450	61

* Based on 8% IACS, rounded to the next higher commercial copper size.

Useful Conversions

Area

Square Inches x 1273 = kcmil
 Square Millimeters x 1.974 = kcmil
 kcmil x 0.5067 = Square Millimeters

Density

Copper: 0.323 lb/in³
 Steel: 0.283 lb/in³

STEEL PIPE SIZES

Standard Weight ASTM® A53-90-B
 (Schedule 40) ANSI®/ASME® B36.10M-1985

Nominal Size (inches)	O.D. (inches)	OD (mm)	Wall Thickness (inches)	Cadweld Mold Code
1	1.315	33.4	.133	1
1-1/4	1.660	42.1	.140	1.25
1-1/2	1.900	48.2	.145	1.50
2	2.375	60.3	.154	2
2-1/2	2.875	73.0	.203	2.50
3	3.500	88.9	.216	3
3-1/2	4.000	101.6	.226	3.50
4	4.500	114.3	.237	4
5	5.563	141.3	.258	5
6	6.625	168.2	.280	6
8	8.625	219.0	.322	8
10	10.750	273.0	.365	10

OTHER STANDARD SECTIONS USED FOR FENCE POSTS

*For D or F mold price only.

Section	Cadweld Mold Code
1-1/2" square	PS15
2" square	PS20
2-1/2" square	PS25
3" square	PS30*
1.875 x 1.625 x .133 "H"	PH1
2.25 x 1.95 .143 "H"	PH2

Index

Part Number	Page	Part Number	Page	Part Number	Page	Part Number	Page
15.....	122	613480.....	17	710200.....	68	B396.....	134
15PLUSF20.....	122	613483.....	17	710210.....	68	B399A.....	137
25.....	122	613840.....	16	815800.....	21	B399AM.....	137
25PLUSF20.....	123	613850.....	16	6113330.....	16	B399B.....	137
32.....	122	613860.....	16	6158330.....	16	B399BM.....	137
32PLUSF20.....	123	613870.....	16	6158660.....	16	B399P.....	131
45.....	122	613880.....	16	6334330.....	19	B399Q.....	137
45PLUSF20.....	123	614400.....	17	6358660.....	19	B548A39.....	80
65.....	122	615800.....	16	A811A26F500.....	57	B548A41.....	80
65PLUSF20.....	123	615803.....	17	ASC0850.....	56	B802D01A72.....	58
90.....	122	615812.....	17	B101CEOL.....	132	BACEAL.....	116
90PLUSF20.....	123	615815.....	17	B101DEOL.....	132	BBCCAJ.....	116
115.....	122	615830.....	16	B101EEOL.....	133	BBCEAL.....	116
115PLUSF20.....	122	615840.....	16	B102CEOL.....	133	BBCPAJ.....	116
150.....	122	615843.....	16	B102EEOL.....	133	BBREAM.....	116
150PLUSF20.....	122	615850.....	16	B112.....	139	BCR8T.....	32
200.....	122	615853.....	16	B117A.....	138	BKEEALAL.....	117
200PLUSF20.....	122	615860.....	16	B117B.....	138	BMCCAJCAJ.....	117
250.....	122	615863.....	16	B117C.....	138	BMCEAJEAJ.....	117
250PLUSF20.....	122	615870.....	16	B120.....	138	BMCEALAL.....	117
300PLUSF20.....	123	615880.....	16	B121CE.....	133	BMCFALFAL.....	117
400PLUSF20.....	123	615883.....	16	B121DE.....	133	BMDEAMEAM.....	117
500.....	122	615900.....	17	B122CE.....	134	BMDPAMPAM.....	117
500PLUSF20.....	123	615950.....	17	B122DE.....	134	C12.....	26
600PLUSF20.....	123	615980.....	17	B1331K.....	139	C19.....	26
750PLUSF20.....	123	631300.....	18	B136A.....	145	C200.....	26
50010EBOSS.....	35	631303.....	18	B136B.....	131	C34.....	26
156650.....	18	631340.....	18	B136B.....	145	C58.....	26
158100.....	20	631350.....	18	B136F.....	145	CBSC10.....	54
158110.....	20	631360.....	18	B13716RH15.....	85	CBSC13.....	54
161635.....	136	631380.....	18	B13722.....	85	CBSC14.....	54
161740.....	136	633400.....	19	B140A.....	140	CBSC16.....	54
161780.....	136	633403.....	19	B140N.....	140	CBSC18.....	54
167900.....	67	633415.....	19	B141A.....	140	CBSC8.....	54
180380.....	139	633430.....	19	B144B.....	140	CC12F.....	18
504550.....	68	633440.....	19	B144C.....	140	CC34.....	18
504590.....	68	633450.....	19	B144M.....	140	CC58.....	18
545020.....	78	633460.....	19	B144Q.....	140	CC5A05CB.....	50
545135.....	65	633463.....	19	B158.....	135	CC5A20CB.....	50
545140.....	65	633470.....	19	B159M.....	134	CC5A40CB.....	50
545530.....	65	633480.....	19	B159V.....	135	CCFR308.....	39
611300.....	16	634400.....	19	B160H.....	135	CCG308.....	39
611303.....	16	635800.....	19	B160V.....	135	CCS-308.....	39
611330.....	16	635803.....	19	B16110B.....	69	CDMV0112.....	131
611340.....	16	635830.....	19	B1622Q.....	68	CDMV0134.....	131
611350.....	16	635840.....	19	B16412A.....	69	CDMV0158.....	131
611353.....	16	635843.....	19	B165.....	70	CDMV01H.....	131
611360.....	16	635850.....	19	B165R.....	70	CMC16EAJ.....	114
611370.....	16	635860.....	19	B166.....	70	CP34.....	26
611380.....	16	635870.....	19	B167.....	70	CP38.....	26
613400.....	17	635880.....	19	B2610A.....	72	CP58.....	26
613403.....	17	635883.....	19	B2617A.....	72	CPC16EAJ.....	114
613412.....	17	663400.....	71	B2618B.....	72	CR100.....	20
613415.....	17	693400.....	17	B265.....	138	CR34.....	20
613440.....	17	693450.....	17	B305SS.....	133	CR58.....	19
613450.....	17	710090.....	20	B305TC.....	133	CSS0810000.....	48
613460.....	17	710100.....	20	B32130.....	143	CTR8CU.....	36
613470.....	17	710190.....	68	B323N2.....	136	CWP1J.....	41

Part Number	Page	Part Number	Page	Part Number	Page	Part Number	Page
CWP1JJ	40	EEB08T506D0A	75	EEB28C506D1A	75	EL6CADB	34
CWP1JU	40	EEB08T506D1A	75	EEB28C506D2A	75	EL6CSNH	34
CWP2J	41	EEB08T506D2A	75	EEB28T506D0A	75	EPGC142144	79
CWP2JU	40	EEB10C506D0A	74	EEB28T506D1A	75	EPGC1426X6	79
CWP4J	40	EEB10C506D1A	74	EEB28T506D2A	75	EPT1225300	28
CWP6J	40	EEB10C506D2A	74	EEB30C506D0A	75	EPT1425350	28
DH12M	85	EEB10T506D0A	75	EEB30C506D1A	75	EPT1450350	28
DH34	84	EEB10T506D1A	75	EEB30C506D2A	75	ESB2	39
DH34M	85	EEB10T506D2A	75	EEB30T506D0A	75	ESB2/0	39
DH58	84	EEB12C506D0A	74	EEB30T506D1A	75	ESB4	39
DH58M	85	EEB12C506D1A	74	EEB30T506D2A	75	ESB4/0	39
DLINKC	76	EEB12C506D2A	74	EEBDLC	76	ESB6	39
DLINKT	76	EEB12T506D0A	75	EEBDLT	76	ESB8	39
DM5834	71	EEB12T506D1A	75	EGBA14206EET	77	ESBP1/0	39
DS12	20	EEB12T506D2A	75	EGBA14212BBT	77	ESBP2	39
DS34	20	EEB14C506D0A	74	EGBA14212EET	77	ESBP2/0	39
DS58	20	EEB14C506D1A	74	EGBA14212HH	78	ESBP350	39
EBCFALFAL	117	EEB14C506D2A	74	EGBA14212TES	78	ESBP4	39
EBL08	81	EEB14T506D0A	75	EGBA14215EET	77	ESBP4/0	39
ECRCHM15LB	25	EEB14T506D1A	75	EGBA14215JJ	78	ESBP6	39
ECRE102Q4D	24	EEB14T506D2A	75	EGBA14215TES	78	ESBP8	39
ECRE152Q4U	24	EEB16C506D0A	74	EGBA14216HH	78	EST401	88
ECRE201T4U	24	EEB16C506D1A	74	EGBA14220DGT	77	EST4620	86
ECRE202C4D	24	EEB16C506D2A	74	EGBA14224EET	77	EST4630	86
ECRE202C4DB	24	EEB16T506D0A	75	EGBA14224GGT	77	EST6472	87
ECRE202G4U	24	EEB16T506D1A	75	EGBA14240EET	77	ESTREELKIT500	88
ECRE352L1UB	24	EEB16T506D2A	75	EGBA14412CC	77	EWB2G9164	46
ECRH082C4U	24	EEB18C506D0A	74	EGBA14412MM	78	EWB2L584	46
ECRH101T4D	24	EEB18C506D1A	74	EGBA14416AAT	77	EWB2Q344	46
ECRH101T4DB	24	EEB18C506D2A	74	EGBA14420HIG	78	FAT-253-50	57
ECRH101T4U	24	EEB18T506D0A	75	EGBA14420LL	78	FC073	43
ECRH101T5U	24	EEB18T506D1A	75	EGBA14424DDT	77	FC074	43
ECRH102C4D	24	EEB18T506D2A	75	EGBA14424MM	78	FC075	43
ECRH102C4U	24	EEB20C506D0A	74	EGBA14436CC	77	FC076	43
ECRH102G4D	24	EEB20C506D1A	74	EGBA14612AA	77	FC078	43
ECRH102G4U	24	EEB20C506D2A	74	EGBA14618AA	77	FC079	43
ECRV101T2U	24	EEB20T506D0A	75	EGBB14212JJ	77	FC080	43
ECRV101T4U	24	EEB20T506D1A	75	EGBC14212NN	77	FC082	43
ECRV102C4U	24	EEB20T506D2A	75	EGBC14412LLT	77	FC082DH	44
ECRV102Q4DB	24	EEB22C506D0A	74	EGBD14224BB	77	FEB35M10	80
ECRV102Q5U	24	EEB22C506D1A	74	EGRD34	84	FMCDMV01	131
ECRV102V4U	24	EEB22C506D2A	74	EGRD34I	84	GC064	27
ECRV122Q4U	24	EEB22T506D0A	75	EGRD58	84	GC065	27
EEB04C506D0A	74	EEB22T506D1A	75	EGRD58I	84	GC065TH	27
EEB04C506D1A	74	EEB22T506D2A	75	EHL12FC1K	25	GEC16	105
EEB04C506D2A	74	EEB24C506D0A	74	EHL12FC1K1K	25	GEM25A	60
EEB04T506D0A	75	EEB24C506D1A	74	EHL12FC1V	25	GEM25ABKT	60
EEB04T506D1A	75	EEB24C506D2A	74	EHL12FC2G	25	GFC16Y3	108
EEB04T506D2A	75	EEB24T506D0A	75	EHL34C1K	25	GLCCES1	51
EEB06C506D0A	74	EEB24T506D1A	75	EHL34C1V	25	GLCCES5	51
EEB06C506D1A	74	EEB24T506D2A	75	EHL34C2G	25	GLCCES7	51
EEB06C506D2A	74	EEB26C506D0A	74	EHL58C1K	25	GR1141G	125
EEB06T506D0A	75	EEB26C506D1A	74	EHL58C1K1K	25	GR1141GPLUS	124
EEB06T506D1A	75	EEB26C506D2A	74	EHL58C1V	25	GR1141L	125
EEB06T506D2A	75	EEB26T506D0A	75	EHL58C2G	25	GR1141LPLUS	124
EEB08C506D0A	74	EEB26T506D1A	75	EK16	44	GR1141V	125
EEB08C506D1A	74	EEB26T506D2A	75	EK17	44	GR1141VPLUS	124
EEB08C506D2A	74	EEB28C506D0A	75	EL4	47	GR1161G	125

Part Number	Page	Part Number	Page	Part Number	Page	Part Number	Page
GR1161GF.....	125	GT1182CPLUS	125	L161A.....	137	MPSC404SS.....	40
GR1161GPLUS.....	124	GT1182G	126	L163.....	134	NDF332Q	104
GR1161L.....	125	GT1182GPLUS	125	L164.....	134	NT1141G.....	126
GR1161LPLUS	124	GTC162Q.....	107	LACS1CE	51	NT1141GPLUS.....	125
GR1161V.....	125	GTC16S1	51	LACS5CE	51	NT1141L.....	126
GR1161VPLUS	124	GTC16S5	51	LACS7DE	51	NT1141LPLUS	125
GR1162C.....	125	GTC16S7	51	LACY5CAJ.....	113	NT1141V	126
GR1162CPLUS.....	124	GTC16Y2	107	LCT25350.....	58	NT1141VPLUS	125
GR1162G.....	125	GTC16Y3	107	LJCEALY2	113	NT1161G.....	126
GR1162GPLUS.....	124	GTC16Y4	107	LJCEALY3	113	NT1161G1TPLUS....	125
GR1162Q.....	125	GTC16Y5	107	LJCEALY4	113	NT1161GPLUS.....	125
GR1162QPLUS.....	124	GTC16Y6	107	LJCPALY4	113	NT1161L.....	126
GR1181G.....	125	GTC18S1	51	LPA502	36	NT1161LPLUS	125
GR1181GPLUS.....	124	GTC18S5	51	LPA513	37	NT1161V	126
GR1181L.....	125	GTC18S7	51	LPA516	35	NT1161VPLUS	125
GR1181LPLUS	124	GTC18Y4	107	LPA540	32	NT1181G.....	126
GR1181V.....	125	GTC18Y6	107	LPA557	33	NT1181GPLUS.....	125
GR1181VPLUS	124	GTC18Y8	107	LPA559	33	NT1181L.....	126
GR1182C.....	125	GTCP200Y6.....	107	LPC331L.....	43	NT1181LPLUS	125
GR1182CPLUS.....	124	GUV16070.....	28	LPC466.....	45	NT1181V.....	126
GR1182G.....	125	GUV70185.....	28	LPC466B.....	40	NT1181VPLUS	125
GR1182GPLUS.....	124	GYR181H.....	108	LPC502.....	36	NX1141G.....	126
GR1182Q.....	125	H101	139	LPC502A.....	36	NX1141GPLUS.....	125
GR1182QPLUS.....	124	H102	139	LPC502L.....	36	NX1141L.....	126
GRC16S1.....	51	H102F.....	139	LPC513.....	37	NX1141LPLUS	125
GRC16S5.....	51	H103	139	LPC516.....	35	NX1161G.....	126
GRC16S7.....	51	H105	139	LPC516A.....	35	NX1161G1T.....	126
GRC16Y3.....	107	H106AF.....	139	LPC516L.....	35	NX1161G1TPLUS....	125
GRC18S1.....	51	H106F.....	139	LPC517.....	35	NX1161GPLUS.....	125
GRC18S5.....	51	H113F.....	139	LPC532.....	32	NX1161L.....	126
GRC18S7.....	51	H117	139	LPC540A.....	32	NX1161LPLUS	125
GRC18Y6.....	107	H11F.....	139	LPC540L.....	32	NX1161V.....	126
GT1141G	125	HAH2G20C.....	109	LPC557.....	33	NX1161VPLUS	125
GT1141GPLUS	124	HAH2G8C.....	109	LPC557L.....	33	NX1181G.....	126
GT1141L	125	HDC1	26	LPC559.....	33	NX1181GPLUS.....	125
GT1141LPLUS	124	HDTAC1L1L	102	LPC559L.....	33	NX1181L.....	126
GT1141V.....	125	HDTAC2G1L.....	102	LPC570.....	41	NX1181LPLUS	125
GT1141VPLUS.....	124	HDTAC2G1V.....	102	LPC570L.....	41	NX1181V.....	126
GT1142GPLUS	124	HDTAC2G2G.....	102	LPC571.....	42	NX1181VPLUS	125
GT1161G	125	HDTAC2Q1L.....	102	LPC580L.....	41	PBD10.....	22
GT1161GPLUS	124	HDTAC2Q1V.....	102	LPC595NB.....	36	PBPLUSCU	142
GT1161L	125	HDTAC2Q2G.....	102	LPC595NB13.....	36	PBS24F.....	139
GT1161LF	125	HDTAC2Q2Q.....	102	LPC5962.....	42	PBWD102	141
GT1161LPLUS	124	IBTB.....	82	LPC5963.....	42	PBWD106	141
GT1161V.....	125	ICECH50C.....	56	LPC5964.....	42	PCC2Q1H.....	100
GT1161VF	125	ICECH70C.....	56	LPC5966.....	42	PG11L.....	132
GT1161VPLUS.....	125	IH1250D.....	63	LPC680.....	71	PG11LPLUS	132
GT1162C	125	IH1250F.....	63	LPC681.....	71	PG11V.....	132
GT1162CPLUS	125	IH1324A.....	63	LPC682.....	69	PGCY4Y4.....	103
GT1162G	125	IH2600E.....	63	LPC706.....	22	PGCY5Y5.....	103
GT1162GPLUS	125	IP900C	64	LPC711.....	22	PGCY6Y6.....	103
GT1181G	125	KA102	132	LPC790.....	29	PIT03	64
GT1181GPLUS	125	KA103	132	MBNC240	37	PLUSCU.....	142
GT1181L	126	KA115	132	MBNC240A.....	37	PTCY1Y1	104
GT1181LPLUS	125	KITCDMV01.....	131	MBNC82	38	PTCY2Y2	104
GT1181V.....	126	KOF103.....	133	MBNUPCJ240.....	46	PTCY3Y1	104
GT1181VPLUS.....	125	L160VG	135	MBNUPCJ82.....	47	PTCY3Y3	104
GT1182C	126	L161.....	137	MESH.....	66	PTCY4Y2	104

Part Number	Page	Part Number	Page	Part Number	Page	Part Number	Page
PTCY4Y3	104	SRGBG100.....	67	TACY8Y5.....	101	VGCY2	111
PTCY4Y4	104	SRGC46	38	TACY8Y7.....	101	VGCY3	111
PTCY5Y3	104	SRGC46BR.....	47	TACY8Y8.....	101	VGCY4	111
PTCY5Y4	104	SSCS1	51	TACY9Y6.....	101	VGPY1M	111
PTCY5Y5	104	SSCS5.....	51	TACY9Y9.....	102	VSCY3	110
PTCY6Y6	104	SSCS7.....	51	TCEC25230	57	VSCY4	110
PTCY8Y6	104	SSCY2	100	TCEC25250	57	WGRS200.....	65
PTCY8Y8	104	SSCY4	100	TC-EC-2530-50	57	XAC2Q2Q	102
QF25	62	SSCY5	100	TCEC25325	57	XACY3Y3	102
RC100	45	SSCY6	100	TCEC25430	57	XACY4Y4	102
RC70	45	SSCY8	100	TCEC25450	57	XACY5Y5	102
RCC10.....	28	SSD10.....	21	TCEC30230	57	XACY6Y5	102
RCC16.....	28	SSR16.....	21	TCEC30250	57	XACY6Y6	102
RCEC6	57	T111.....	144	TCEC38510	57	XACY7Y7	102
RC-EC-8	57	T302A.....	145	TCEC38630	57	XADY9Y6	102
RC-ET-8.....	57	T306.....	148	TCEC405030	57	XADY9Y9	102
RSCC1030.....	57	T313.....	144	TCEC50430	57	XB3Y6Y6.....	103
RSCC1050.....	57	T314.....	145	TCEC50450	57	XB4Y8Y8.....	103
RSCC2SS830	57	T314A.....	145	TCEC50620	57	XBQY4Y4	103
RSCC2SS850	57	T315A.....	147	TCEC50630	57	XBQY5Y5	103
RSCC4SS1030	57	T319.....	141	TCEC50650	57	XBQY6Y6	103
RSCC4SS1050	57	T320.....	143	TCECT25230	58	XBZY8Y8	103
RSCC4SS830	57	T320A.....	143	TCECT25250	58	XL115.....	123
RSCC4SS850	57	T321.....	146	TC-ECT-253	58	XL15.....	123
RSCC8100.....	57	T321A.....	146	TCECT25350	58	XL25.....	123
RSCCA1330	56	T328.....	147	TCECT30230	58	XL32.....	123
RSCCA1350	56	T328D	139	TCECT30250	58	XL45.....	123
RSCCA830	56	T343.....	147	TCECT30275	58	XL90.....	123
S02F	139	T372A.....	141	TCECT3850	58	XLB971A1	144
S03F	139	T378L.....	146	TCECT5060	58	XLB974B2.....	148
S05F	139	T393.....	146	TCHGS40430.....	58	ZWP1J	40
S07F	139	T394.....	145	TCHGSP303530	58		
S17F	139	T396.....	147	TCHGSP303550	58		
S2904A.....	141	T403.....	142	TCHSS303530	58		
S2904B	141	T416B	63	TCHSS303550	58		
S2904C	141	T416C.....	63	TCHSSP303530.....	58		
S429F2J16.....	139	T427.....	140	TCHSSP303550.....	58		
S429F2N16.....	139	TAC2Q1L.....	101	TDSGABC14.....	80		
S429F3S20.....	139	TAC2Q2Q.....	101	TDSGAPC14.....	81		
SBCS0810.....	34	TACY1Y1.....	101	TDSGAWB17	81		
SBCS1314.....	34	TACY2Y2.....	101	TGBA12L06P	78		
SBD50.....	142	TACY3Y3.....	101	TGBA12L06PT	78		
SBD51.....	142	TACY4Y1.....	101	TGBA20L12PT	78		
SBD55.....	142	TACY4Y2.....	101	TGBA24L14P	78		
SC34	19	TACY4Y4.....	101	TGBA24L14PT	78		
SCDM01.....	131	TACY4Y6.....	101	TGBA29L18PT	78		
SCR15.....	22	TACY5Y2.....	101	TMGBA12L15P	79		
SCR20.....	22	TACY5Y3.....	101	TMGBA12L15PT	79		
SDT34	20	TACY5Y5.....	101	TMGBA20L27P	79		
SDT58	20	TACY5Y6.....	101	TMGBA24L33PT	79		
SEB-06	78	TACY5Y7.....	101	TMGBA29L41PT	79		
SEB08.....	78	TACY6Y1.....	101	TSCSTP.....	131		
SEB-10	78	TACY6Y2.....	101	UB16.....	27		
SP58	26	TACY6Y3.....	101	UB20.....	27		
SRC15.....	28	TACY6Y4.....	101	UB25.....	27		
SRC20.....	28	TACY6Y5.....	101	VBC2G	110		
SRGBD100.....	67	TACY6Y6.....	101	VBCY6	110		
SRGBE100	67	TACY7Y7.....	101	VGCY1	111		

Our powerful portfolio of brands:

CADDY ERICO HOFFMAN RAYCHEM SCHROFF TRACER



[nVent.com/ERICO](https://www.nVent.com/ERICO)

nVent products shall be installed and used only as indicated in nVent's product instruction sheets and training materials. Instruction sheets are available at [nVent.com/ERICO](https://www.nVent.com/ERICO) and from your nVent customer service representative. Improper installation, misuse, misapplication or other failures to completely follow nVent's Instructions and warnings may cause product malfunction, property damage, serious bodily injury and death and/or void your warranty.

©2020 nVent. All nVent marks and logos are owned or licensed by nVent Services GmbH or its affiliates. All other trademarks are the property of their respective owners. nVent reserves the right to change specifications without notice.

ERICO-CAT-E1339C-GroundingBondingCadweld-UKEN-2004